



# Harmonic Mitigating Remote Panelboards (HMRP)

**Owner's Manual**





---

# IMPORTANT SAFETY INSTRUCTION

**SAVE THESE INSTRUCTIONS** - This manual contains important instructions for the ONICS™ HMRP that must be followed during installation, operation, and maintenance of the ONICS™ HMRP and its auxiliary equipment.

	<p style="text-align: center;"><b>WARNING</b></p> <p style="text-align: center;">OPENING ENCLOSURES EXPOSES HAZARDOUS VOLTAGES. ALWAYS REFER SERVICE TO QUALIFIED PERSONNEL ONLY.</p>
---	---

	<p style="text-align: center;"><b>WARNING</b></p> <p>As standards, specifications, and designs are subject to change, please ask for confirmation of the information given in this publication.</p> <p>This manual is a controlled document; pages should not individually be removed from this document.</p>
---	---

	<p style="text-align: center;"><b>NOTE</b></p> <p style="text-align: center;">This equipment has been tested and found to comply with the limits for a Class A digital device, pursuant to part 15 of the FCC Rules. These limits are designed to provide reasonable protection against harmful interference when the equipment is operated in a commercial environment.</p>
---	--

---

The logo for ONICS™, featuring the word "ONICS" in white, bold, sans-serif capital letters with a trademark symbol, set against a solid green rectangular background.

# Harmonic Mitigating Remote Panelboards (HMRP)

## Owner's Manual

For service call  
1 - 888 - TO - MIRUS  
1 - 888 - 866 - 4787

HMRP-M001-A7  
Copyright ©  
All rights reserved. Printed in Canada

MIRUS International Inc.  
31 Sun Pac Blvd.  
Brampton, Ontario  
Canada L6S 5P6

Tel: (905) 494-1120  
Fax: (905) 494-1140  
E-Mail: [mirus@mirusinternational.com](mailto:mirus@mirusinternational.com)  
Website: [www.mirusinternational.com](http://www.mirusinternational.com)



---

# ONICS™ Harmonic Mitigating Remote Panelboards (HMRP) Owner's Manual

---

## Warranty

Seller warrants to the Ultimate Purchaser (the purchaser who buys for use, and not for resale) that all products furnished under this order and which are manufactured by Seller will conform to final specifications, drawings, samples and other written descriptions approved in writing by Seller, and will be free from defects in materials and workmanship. These warranties shall remain in effect for period of twelve (12) months after delivery to the Ultimate Purchaser. But if the Seller installs the equipment or supplies technical direction of installation by contract, said one year shall run from the completion of installation, provided installation is not unreasonably delayed by Ultimate Purchaser. Parts replaced or repaired in the warrant period shall carry the unexpired portion of the original warranty. A unit placed with the Purchaser on consignment and then later purchased will be warranted for twelve (12) months from the time the Seller receives notification of the Purchaser's intent to purchase said consigned item. The foregoing in its entirety is subject to the provision that in no case will the total warranty period extend beyond 18 months from date Seller ships equipment from point of manufacture.

The liability of Seller hereunder is limited to replacing or repairing at Seller's factory or on the job site at Seller's option, any part or parts which have been returned to the Seller and which are defective or do not conform to such specifications, drawings or other written descriptions; provided that such part or parts are returned by the Ultimate Purchaser within ninety (90) days after such defect is discovered. The Seller shall have the sole right to determine if the parts are to be repaired at the job site or whether they are to be returned to the factory for repair or replacement. All items returned to Seller for repair or replacement must be sent freight prepaid to its factory. Purchaser must obtain Seller's Return Materials Authorization (RMA) prior to returning items. The above conditions must be met if warranty is to be valid. Seller will not be liable for any damage done by unauthorized repair work, unauthorized replacement parts, from any misapplication of the item, or for damage due to accident, abuse, or Act of God.

In no event shall the Seller be liable for loss, damage, or expense directly or indirectly arising from the use of the units, or from any other cause, except as expressly stated in this warranty. Seller makes no warranties, express or implied, including any warranty as to merchantability or fitness for a particular purpose or use. Seller is not liable for and Purchaser waives any right of action it has or may have against Seller for any consequential or special damages arising out of any breach of warranty, and for any damages Purchaser may claim for damage to any property or injury or death to any person arising out of its purchase of the use, operation or maintenance of the product. Seller will not be liable for any labor subcontracted or performed by Purchaser for preparation of warranted item for return to Seller's factory or for preparation work for field repair or replacement. Invoicing of Seller for labor either performed or subcontracted by Purchaser will not be considered as a liability by the Seller.

This warranty shall be exclusive of any and all other warranties express or implied and may be modified only by a writing signed by an officer of the Seller. This warranty shall extend to the Ultimate Purchaser but to no one else. Accessories supplied by Seller, but manufactured by others, carry any warranty the manufacturers have made to Seller and which can be passed on to Ultimate Purchaser.

Seller makes no warranty with respect to whether the products sold hereunder infringe any patent, U.S., Canadian or foreign, and Buyer represents that any specially ordered products do not infringe any patent. Buyer agrees to indemnify and hold Seller harmless from any liability by virtue of any patent claims where Buyer has ordered a product conforming to Buyer's specifications, or conforming to Buyer's specific design.

Buyer has not relied and shall not rely on any oral representation regarding the Product sold hereunder and any oral representation shall not bind Seller and shall not be part of any warranty.

There are no warranties which extend beyond the description on the face hereof. In no event shall MIRUS International Inc. be responsible for consequential damages or for any damages except as expressly stated herein.

---

## Service and Factory Repair - Call 1 - 888 - TO - MIRUS (1 - 888 - 866 - 4787)

Direct questions about the operation, repair, or servicing of this equipment to MIRUS International Inc. Customer Support Services. Include the part number, assembly number, and serial number of the unit in any correspondence. Should you require factory service for your equipment, contact MIRUS International Inc. Customer Support Services and obtain a Return Materials Authorization (RMA) prior to shipping your unit. Never ship equipment to MIRUS International Inc. without first obtaining an RMA.

---

## Proprietary Rights Statement

The information in this manual is the property of MIRUS International Inc., and represents a proprietary article in which MIRUS International Inc., retains any and all patent rights, including exclusive rights of use and/or manufacture and/or sale. Possession of this information does not convey any permission to reproduce, print, or manufacture the article or articles shown herein. Such permission may be granted only by specific written authorization, signed by an officer of MIRUS International Inc.

ONICS™ Harmonic Mitigating Power Center (HMRP) and Harmony™ are trademarks of MIRUS International Inc. Other trademarks that may be used herein are owned by their respective companies and are referred to in an editorial fashion only.

---

## Revision History

Copyright ©	All rights reserved. Printed in Canada
Revision: A7	New Release 2011/02/01

---

# Contents

---

## **Introduction**

<b>Section</b>	<b>Description</b>	<b>Page Number</b>
1.0	Scope	1
1.1	System description	2
1.2	Major Components	5
1.3	Model Numbering	9
1.4	Options	9
1.5	HMRP Specifications	10
1.6	The HF3579™ Electromagnetic Harmonic Filter Benefits	11
1.6.1	Balancing Loads for optimum 5 <sup>th</sup> and 7 <sup>th</sup> harmonic cancellation	11
1.6.2	Capacitive reactance compensation	12
1.7	Balancing Loads for the HF3579™ Harmonic Filter	12

## **Installation**

2.0	Scope	13
2.1	Receiving	13
2.2	Handling	14
2.3	Storage	18
2.4	Prerequisite to Installation	18
2.5	Installation Procedures	21
2.5.1	Placement	21
2.5.2	Connections	22
2.5.3	Connection Configuration Modes	24
2.5.4	Finishing the Installation	25
2.6	Startup Procedures	25
2.6.1	Checks Before Startup	25
2.6.2	Initial Startup	25
2.6.3	Checks After Startup	25

## **Maintenance**

3.0	Scope	29
3.1	Preventive maintenance	29
3.2	Troubleshooting	30

## **Appendix**

4.0	Specifications / Data	33
4.1	Breaker and Fuse Ratings	34

**Illustrations**

<b>Figure</b>	<b>Description</b>	<b>Page Number</b>
1-1	Onics™ HMRP Dimensional Layout	2
1-2	Onics™ HMRP internal layout of major internal components	2
1-3	Single-line diagram of Onics™ HMRP with HF3579™ Harmonic Filter	3
1-4	Typical Schematic of HMRP with HF3579™ Harmonic Filter	3
1-5	Power Monitor front panel	6
1-6	Nomenclature of HMRP	9
2-1	Removing HMRP from Pallet	15
2-2	HMRP bottom view showing leveling feet	16
2-3	HMRP outer dimensions	17
2-4	Placement showing floor tile cut-outs	19
2-5	Grounding within the HMRP electrical path	21
2-6	Leveling jacks	22
2-7	Hinge removal for trims	24
2-8	HMRP Layout	26

**Tables**

<b>Table</b>	<b>Description</b>	<b>Page Number</b>
1-1	HMRP Characteristics	4
1-2	Available Power Monitor Configurations	6
1-3	Power Monitor Display Features	7 to 8
1-4	HMRP Specifications	10
2-1	Conductor coding	23
4-1	Weight and dimensional data	33
4-2	Main and subfeed breakers torque specifications	33
4-3	Branch breaker torque specifications	33
4.4	Breaker and Fuse Ratings	34

This manual has been designed for ease of use and easy location of information.

**How to use this manual**

To quickly find the meaning of terms used within the text, look to the Glossary.

This manual uses Note boxes to convey important information. Note boxes come in four varieties:

	<p style="text-align: center;"><b>WARNING</b></p> <p>A <b>WARNING</b> note box indicates information provided to protect the user and service personnel against safety hazards and/or possible equipment damage.</p>
---	--

	<p style="text-align: center;"><b>CAUTION</b></p> <p>A <b>CAUTION</b> note box indicates information provided to protect the user and service personnel against possible equipment damage.</p>
---	--

	<p style="text-align: center;"><b>IMPORTANT</b></p> <p>An <b>IMPORTANT</b> note box indicates information provided as an operating instruction or as an operating tip.</p>
---	--

	<p style="text-align: center;"><b>NOTE</b></p> <p>A <b>NOTE</b> note box indicates information provided as an operating tip or an equipment feature.</p>
---	--





---

# 1

# Introduction

---

## 1.0 Scope

This manual provides information required for installation, operation, and maintenance of the **ONICS™ Harmonic Mitigating Remote Panelboards (HMRP)**. Please read this manual thoroughly before installing and operating your HMRP. Retain this manual for future reference.

The manual is divided into four sections:

### **Section I - Introduction**

This section introduces the HMRP (see Figure 1-1 and 1-2), including a general description of the system and its internal components, a description of available options, and system specifications.

### **Section II - Installation**

This section describes installation of the HMRP, including receiving, handling, and storage procedures; prerequisites to installation; installation procedures; and start-up procedures.

### **Section III - Operation**

This section presents operating information for the HMRP, including an overview of the system, its components, and their function; a description of the indicators and controls, and their function; and operational sequences to be followed for all conditions of normal, emergency, and maintenance operation.

### **Section IV - Maintenance**

This section describes maintenance of the HMRP, including preventive maintenance, troubleshooting, and information about replacement parts.

A Glossary in the rear of the manual provides definitions of terms used within the text.

## 1.1 System Description

The HMRP is capable of serving as a power distribution center for most types of loads but is especially suited for non-linear loads. The HMRP takes input power and distributes that power to load devices. The HMRP monitors the supplied power when optional metering is selected. Single-line diagram and typical schematic are shown in Figure 1-3 and Figure 1-4.

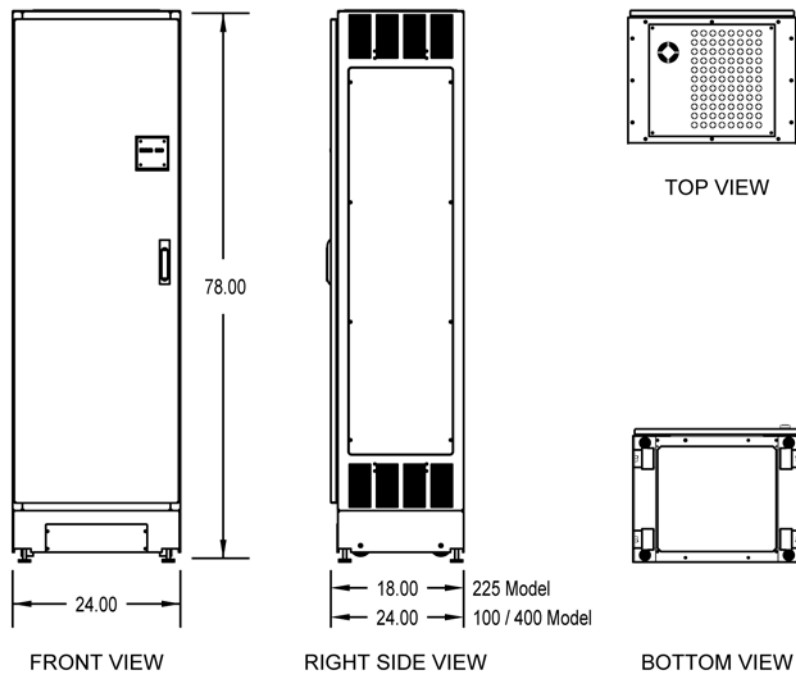

**Figure 1-1 ONICS™ HMRP Dimensional Layout**

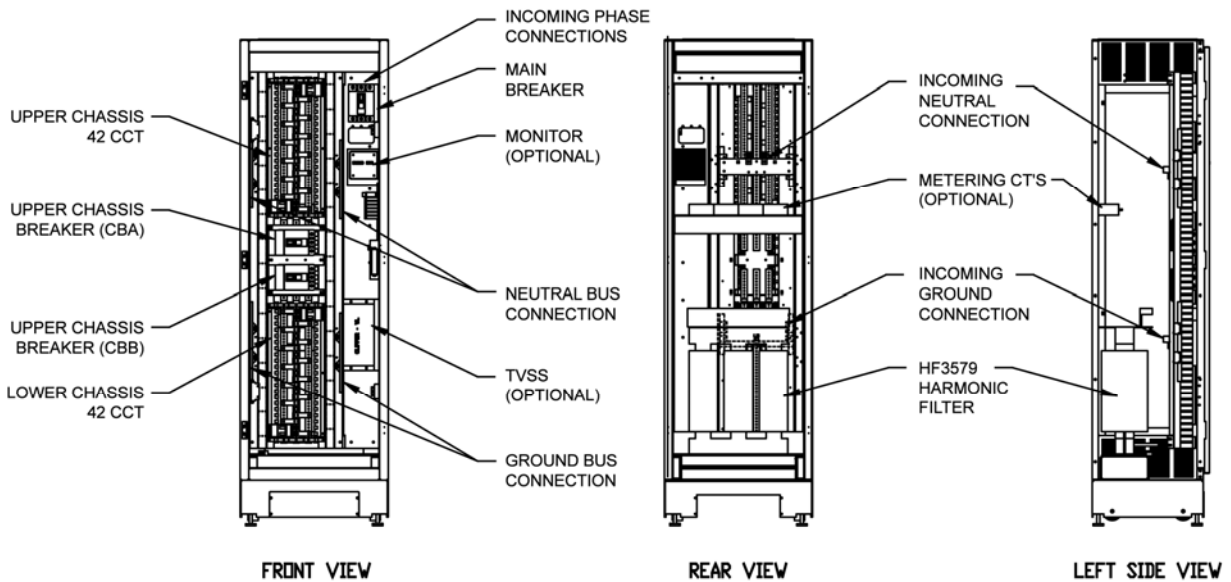

**Figure 1-2 ONICS™ HMRP Internal layout and location of major internal components**

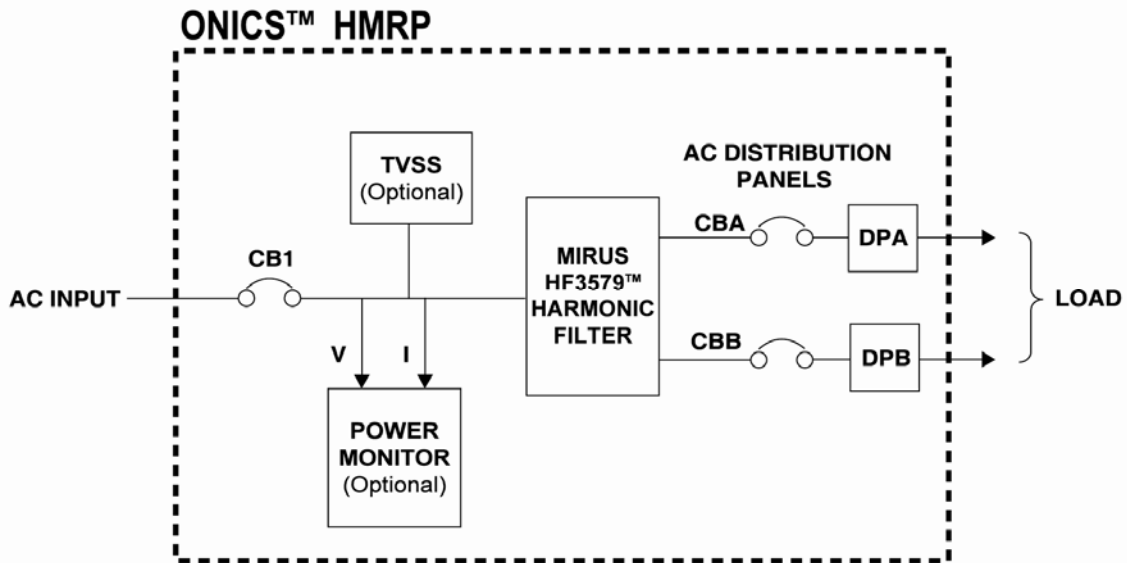

Figure 1-3 Single-line diagram of ONICS™ HMRP with HF3579™ Harmonic Filter

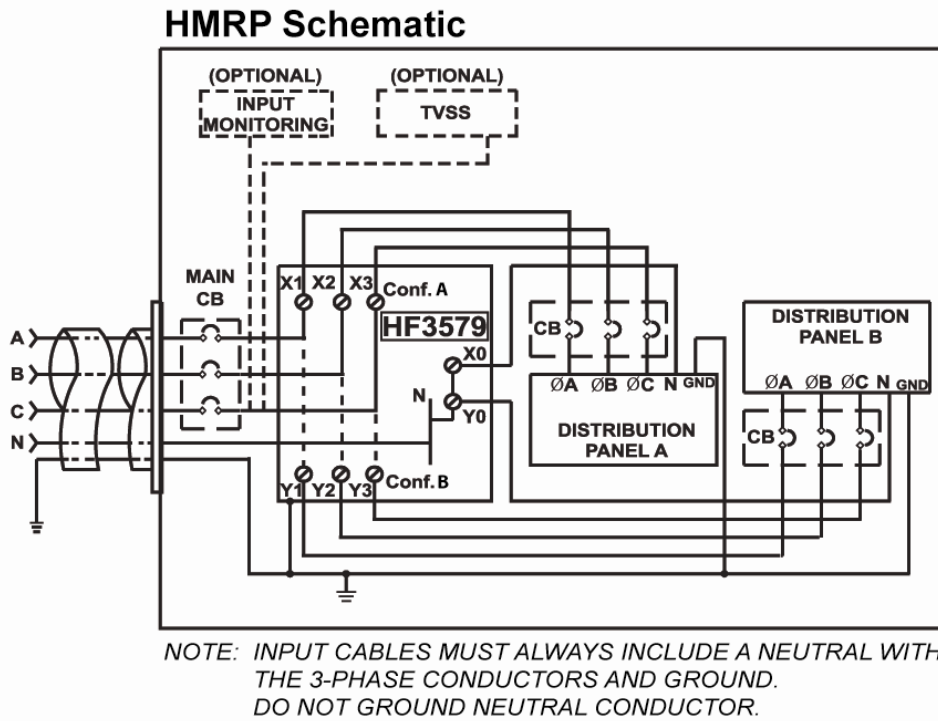

Figure 1-4 Typical schematic of HMRP with HF3579™ Harmonic Filter (Models 225 & 400)

## ONICS™ Harmonic Mitigating Remote Panelboards (HMRP)

---

For most applications, the HMRP is completely self-contained within a single enclosure comprised of one modular section. The enclosure may house one optional monitor, and up to two distribution panelboards (total of 84 poles for 208/120V models and 60 poles for 480-415/240V models). One of the panelboards may be substituted by a larger molded-case circuit breaker (one 225 amps maximum).

The HMRP is available in sizes 180 Amp and 400 Amp in 208/120V models and 100 Amp in 480-415/240V models. A range of options are available including:

- Transient voltage suppression system (TVSS)
- Power Monitor or Power Monitor with communications
- Isolated ground bus
- Sub-Feed Molded-case circuit breaker

The HMRP is Listed for Safety by Underwriter's Laboratories, Inc., (UL) Listed 60950-1 Information Technology Equipment – Safety, and meets the standards for the National Electrical Code (NEC) and the Occupational Safety and Health Act (OSHA).

Model number information, along with associated power and size, is given in Table 1-1.

Size	Model Nos.	Voltage In/Out	Current [Amps]	Shipping Weight lbs [kg]
225	HMRP-084-A-225-HF3579	208/120V	180A	750 [340]
400	HMRP-084-A-400-HF3579	208/120V	400A	1070 [485]
100	HMRP-060-BI-100-HF3579	480-415/240V	100A	900 [408]

**Table 1-1**     **HMRP Characteristics**

## 1.2 Major Components

The following is a description of the major components of the HMRP. Refer to Figure 1-2.

### Circuit Monitor and Indicators

Figure 1-1 shows the external view of the unit with the monitor.

The meter is an 'optional' three-phase, digital multi-function power monitor providing simultaneous displays, remote capabilities and optional power quality analysis. It measures every electrical power function including: voltage, current, frequency, KW, KVAR, KVA, PF, total KWH, and total harmonic distortion. Some functions are optional (refer to Tables 1-2 and 1-3).

'Emergency power off' (EPO). The HMRP comes equipped with an 'optional' Shunt Trip unit on the Main Circuit Breaker. Terminals are provided for connection of a customer supplied pushbutton which shuts down the HMRP thereby disconnecting all power downstream of the input circuit breaker.

'TVSS alarm' is triggered by the 'optional' transient voltage suppression system.

'HF3579™ Overtemp' is triggered when the Harmonic Filter temperature reaches 170°C. When triggered the Temperature will change state from Normally Closed NC to Normally Open NO signifying an Over temperature Alarm Status.

'Alarm Status" is triggered by any fault condition from the 'optional' power monitor when monitor is equipped with relay output option.

'MIRUS HF3579™ Harmonic Filter' is located behind the panelboards. Connections are accessible by removing the side panel of the ONICS™ HMRP.

**Power Monitor (optional)**

The Power Monitor is supplied in various configurations. The following table describes the types of monitors available with their option code.

**POWER MONITOR :**

Option Code	Description
M0	No Meter
M1	Power Monitor
M1R	Power Monitor with Relay O/P
M1C	Power Monitor with RS232 Communication
M1RC	Power Monitor with Relay O/P & RS232 Communication
M2	Advanced Power Monitor with Ethernet
M2R	Advanced Power Monitor with Ethernet & Relay O/P

**Table 1-2 Available Power Monitor Configurations**



**Figure 1-5 Power Monitor Front Panel**

POWER MONITOR DISPLAY:	M1	M1R	M1C	M1RC	M2	M2R
<b>Measurements</b>						
Voltage (L-L)	Std	Std	Std	Std	Std	Std
Voltage (L-N)	Std	Std	Std	Std	Std	Std
Current Per Phase	Std	Std	Std	Std	Std	Std
Watts	Std	Std	Std	Std	Std	Std
VA <sub>r</sub>	Std	Std	Std	Std	Std	Std
VA	Std	Std	Std	Std	Std	Std
PF	Std	Std	Std	Std	Std	Std
+ Watt-hr	Std	Std	Std	Std	Std	Std
- Watt-hr	Std	Std	Std	Std	Std	Std
Watt-hr net	Std	Std	Std	Std	Std	Std
+ VAR-hr	Std	Std	Std	Std	Std	Std
- VAR-hr	Std	Std	Std	Std	Std	Std
VAR-hr net	Std	Std	Std	Std	Std	Std
VA-hr	Std	Std	Std	Std	Std	Std
Frequency	Std	Std	Std	Std	Std	Std
%THD	Std	Std	Std	Std	Std	Std
Voltage Angles	Std	Std	Std	Std	Std	Std
Current Angles	Std	Std	Std	Std	Std	Std
% Load Bar	Std	Std	Std	Std	Std	Std

**Table 1-3 Power Monitor Display Features**

(Table 1-3 continued on next page) →

**ONICS™ Harmonic Mitigating Remote Panelboards (HMRP)**

---

(Table1-3 continued)

<b>POWER MONITOR DISPLAY:</b>	<b>M1</b>	<b>M1R</b>	<b>M1C</b>	<b>M1RC</b>	<b>M2</b>	<b>M2R</b>
<b>Harmonic Measurements</b>						
Phase Voltage %THD	Std	Std	Std	Std	Std	Std
Phase Current %THD	Std	Std	Std	Std	Std	Std
Phase Current K Factor	Std	Std	Std	Std	Std	Std
Harmonic Magnitudes	Std	Std	Std	Std	Std	Std
Harmonic Angles	Std	Std	Std	Std	Std	Std
<b>Communications</b>						
RS232	N/A	N/A	Std1	Std2	N/A	N/A
RS485	N/A	N/A	Std2	Std2	N/A	N/A
Ethernet	N/A	N/A	N/A	N/A	Std	Std

**Table 1-3 (cont.) Power Monitor Display Features**



### 1.3 Model Numbering

The model number of the unit, located on the inside, can be parsed to indicate important parameters of the HMRP.

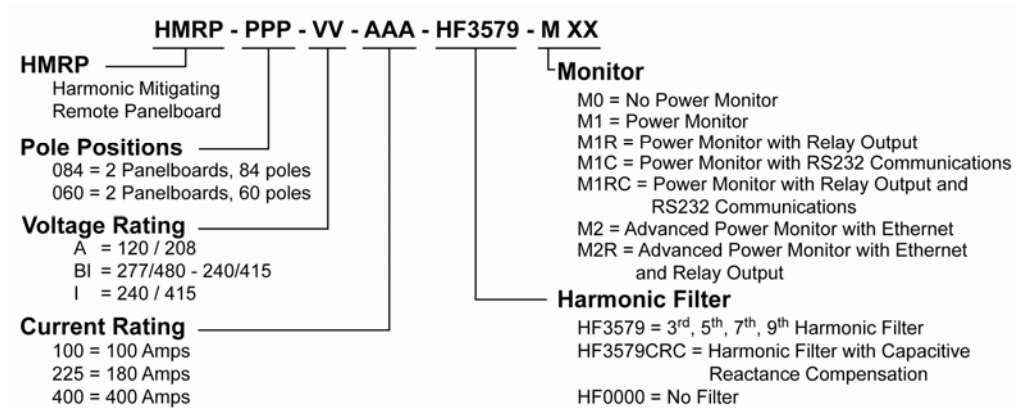

**Figure 1-6 Nomenclature of HMRP**

### 1.4 Options

Most options must be specified at the time of the original order for factory installation. Some options can be field installed; contact your MIRUS Sales Representative for further information.

#### **Transient voltage suppression system (TVSS)**

Transient voltage suppression system (TVSS), which is connected to the output (secondary) side of the main isolation transformer, is used to clip voltage transients. Installed internally in the HMRP.

#### **Isolated ground bus**

Isolated ground bus provides a termination point for the second ground wire from isolated ground receptacles. Installed internally in the HMRP.

#### **Floor stand**

Floor stand is used in applications where a raised floor installation is not possible and top or side conduit landings cannot be used.

#### **Distribution circuit breakers**

Distribution circuit breakers can be factory installed. Up to 125 A/3 pole circuit breakers can be installed on panelboard B. All other panelboards accept 1-, 2-, or 3-pole circuit breakers rated up to 100Amps / 3 pole. Filler plates are provided with each unit and must be installed where there are no breakers installed.

**Optional Remote emergency power off (REPO)**

Remote emergency power off (REPO) station makes it possible to disconnect power to the HMRP from a remote location in an emergency. When the REPO is activated, it trips the main input circuit breaker. The HMRP shuts down, along with all connected loads. Any number of REPO stations can be connected as required.

**Sub Feed Main frame circuit breaker in place of pole positions**

Main frame circuit breaker can be installed in place of panelboard B. One main frame circuit breaker up to 225A can be installed.

**1.5 HMRP™ Specifications**

Model	225	400	100
Voltage- In/Out (3-ph, 4-wire +gnd):	120/208V	120/208V	277/480V – 240/415V
Frequency:	60 Hz	60 Hz	60 Hz
Current Rating:	180Amp	400Amp	100Amp
Harmonics Treated	3rd, 5th, 7th, 9th & others	3rd, 5th, 7th, 9th & others	3rd, 5th, 7th, 9th & others
Efficiency @ 35 to 65% Load	> 98.7%	> 99.1%	> 99.2%
K-factor suitability	20	20	20
Crest factor suitability	4.5	4.5	4.5
Heat Dissipated	< 3200 BTU/hr	< 6400 BTU/hr	< 2800 BTU/hr
Audible Sound Level	< 43dB	<45dB	<43dB
Elevation (above sea level)	< 6561ft [2000m]	< 6561ft [2000m]	< 6561ft [2000m]
Operating Ambient Temp.	-10°C to +40°C	-10°C to +40°C	-10°C to +40°C
Ventilation	Convection air cooled	Convection air cooled	Convection air cooled
Dimensions	24"W x 19"D x 78"H	24"W x 24"D x 78"H	24"W x 24"D x 78"H
Weight	580 lbs	890 lbs	600 lbs
Panelboards	2 x 42-circuit, c/w 125 Amp main CB	2 x 42-circuit, c/w 225 Amp main CB	2 x 30-circuit, c/w 75 Amp main CB
Main CB	225 Amp	400 Amp	125 Amp
Enclosure Finish	Textured baked enamel Black	Textured baked enamel Black	Textured baked enamel Black

**HMRP™ Options**

Input Power Monitor	Standard or Advanced	Standard or Advanced
TVSS (UL1449)	80kA or 100kA surge capacity with EMI/RFI noise filtering	80kA or 100kA surge capacity with EMI/RFI noise filtering

**HF3579™ Harmonic Filter**

Harmonics Treated:	3 <sup>rd</sup> , 5 <sup>th</sup> , 7 <sup>th</sup> , 9 <sup>th</sup> and others	3 <sup>rd</sup> , 5 <sup>th</sup> , 7 <sup>th</sup> , 9 <sup>th</sup> and others
Phase shift:	30°	30°

**Table 1-4 HMRP Specifications**

## 1.6 HF3579™ Electromagnetic Harmonic Filter and Its Benefits

At the heart of every ONICS™ Harmonic Mitigating Remote Panelboard (HMRP) is a MIRUS HF3579 Electromagnetic Harmonic Filter. The unique configuration of the HF3579 combines low zero sequence impedance windings with phase shifting to provide filtering of the 3<sup>rd</sup>, 5<sup>th</sup>, 7<sup>th</sup> and 9<sup>th</sup> order harmonic currents generated by 1-phase non-linear loads. This is accomplished without the use of capacitors.

3<sup>rd</sup>, 9<sup>th</sup> and other neutral current harmonics are diverted away from the neutral conductor by the HF3579. Through flux cancellation within its windings, the filter provides a lower impedance parallel path for these zero sequence currents to flow. This removes them from the neutral and returns them to the loads via the phase conductors. Upstream transformers and cables no longer need to supply these harmonic currents resulting in lower losses and eliminating the need for K-rated transformers and double ampacity neutrals.

The windings in the HF3579 are also configured such that a 30° phase shift is introduced between the loads on each panelboard. This places the 5<sup>th</sup> and 7<sup>th</sup> harmonic currents returning from one panelboard 180° out-of-phase with those currents returning from the other panelboard. This provides further reduction in the total harmonic current flowing upstream from the HMRP.

With the recent trend towards 'Green' Data Centers distributing power at 415/240V, the HMRP has been made available in a 480/277V - 415/240V model. This allows for standard 480V distribution to the HMRP. The Harmonic Filter and autotransformer are combined into one magnetic package to save space and reduce losses.

By substantially reducing the harmonic currents, the HF3579 reduces harmonic voltage distortion and restores the supply voltage peak. This is extremely important because a flat-topped voltage waveform can adversely affect the operation of all connected equipment, including the switch-mode power supplies (SMPS) that have generated the harmonic currents and created the problem. It is now not uncommon to find distribution systems with 1-phase non-linear loads that have RMS voltages which are only marginally low but with peak voltages which are more than 10% low.

One of the consequences of this voltage flat-topping is an increase in losses within the SMPS. For example, a 10% decrease in peak voltage (ie. from 170V to 153V) will increase the SMPS line current by about 11% which will in turn increase the I<sup>2</sup>R portion of the SMPS losses by about 23%. In addition, a 10% reduction in peak voltage will also reduce the power dip ride-through time of the computer load by about 37%. Thus an HMRP equipped with an HF3579 will improve overall system reliability by preventing flat-topping from developing.

### 1.6.1 Balancing Loads for optimum 5<sup>th</sup> and 7<sup>th</sup> harmonic cancellation

The ONICS™ HMRP is equipped with 2 power distribution panelboards which allow the loads to be easily split for optimal harmonic cancellation. By sharing the loads between the 2 panelboards in approximately equal parts (in kVA or in amperes), 5<sup>th</sup> and 7<sup>th</sup> harmonics will be cancelled. It is very important to note that excellent harmonic cancellation can be achieved even without precise load balancing. For example, a 60 to 40 load split will reduce 5<sup>th</sup> and 7<sup>th</sup> harmonics from 100 to 20, a very worthwhile 5 to 1 improvement.

### **1.6.2 Capacitive reactance compensation**

In an effort to help address the burgeoning harmonic problem, some higher end computer equipment is now being equipped with power factor corrected power supplies. Although these power supplies do substantially reduce harmonics, they have introduced a new power quality issue - capacitive loading. Most power factor corrected power supplies incorporate additional capacitance to reduce harmonics. Unfortunately, when this equipment is running lightly loaded (which is very often the case) the capacitors often overcompensate resulting in a leading power factor load. Power systems in general typically do not like a leading power factor load but the output filters on UPS systems are particularly sensitive to them. As a result, UPS systems have been known to lose output filters due to the capacitive reactance of the loads even when supplying loads that are substantially under their rated capacity.

As an inductive device, the HF3579 can be used to compensate for the capacitive reactance of power factor corrected power supplies. This will prevent UPS output filter overloading and free up capacity in the UPS as well as other components of the distribution system. Therefore, by offering both harmonic mitigation and capacitive reactance compensation, the HMRP is ideally suited for supplying today's power electronic loads regardless of whether they are equipped with the more common non-linear power supplies or the latest power factor corrected power supplies.

### **1.7 Attracting Harmonics From Upstream Systems**

The HF3579™ Harmonic Filter consists of both a series connected component and a parallel connected component. The parallel connected component may attract harmonics from upstream loads. To control the level of attraction, the HMRP comes with two connection configurations. When connected in Configuration A, less upstream harmonics will be drawn into the filter. The unit is normally shipped in this configuration. If harmonics are not too severe, switching to Configuration B can improve harmonic mitigating performance. For instructions on configuration connections, see section 2.5.

Note: Due to the parallel component of the HF3579, harmonics may be attracted from the upstream power system. Therefore, the appearance of some current on the input phase conductors and neutral even with no load on the HMRP is common and perfectly acceptable provided it is not too excessive.

---

## 2

## Installation

---

### 2.0 Scope

This section describes installation of the **ONICS™ Harmonic Mitigating Remote Panelboards (HMRP)**, including receiving, handling, and storage procedures, prerequisites to installation, installation procedures, and start-up procedures.

### 2.1 Receiving

Every effort is made to insure that the HMRP equipment arrives at its destination undamaged and ready for installation. Crating and packing is designed to protect internal components as well as the enclosure. The HMRP enclosures are skid mounted and suited for forklift movement, thus care should be exercised to protect the equipment from impact at all times.

Before accepting the shipment from the freight carrier, inspect the exterior surfaces of shipping container(s), packaging, and equipment for damage that may have occurred during transit. If the shipping containers or equipment show evidence of damage, note the damage on the receiving document (bill of lading) prior to signing for receipt of equipment.

The equipment should be unpacked immediately after receipt, and inspected again for damage to external painted panels and doors and to determine if any internal damage (broken components, disconnected wiring, loose connections, etc.) has occurred. Verify that the equipment nameplate corresponds with the equipment ordered. The rating nameplate is located on the inside surface of the main enclosure door.

	<p><b>NOTE</b></p> <p>The unit should not be loosened from the shipping pallet until after all handling by forklift or pallet jack is completed. Complete internal inspection should be conducted only after the equipment has been positioned prior to electrical connection.</p>
---	--

RECORD any external and internal damage observed for reporting to the transportation carrier. Call the carriers concerned at once for inspection, and request an inspection report. Do not contact Mirus International Inc. first – notify the carrier instead. If this precaution is not taken we cannot assist you in recovering the amount of the claim against the carrier. All claims should be as specific as possible and include purchase order (P.O.#) and serial numbers (S/N #), found on the nameplate.

A shipping label is affixed to the top of the shipping container which includes a variety of equipment and customer information, such as Purchase Order Number (P.O.#). Make certain that this information matches other shipping paper information.

Each HMRP is lagged to and shipped on a pallet. The pallet is opened at two ends for movement by a forklift. The entire unit is protected with shrink-wrap and may or may not be banded to the skid.

	<b>WARNING</b>
	THE SHIPPING BANDS MAY BE UNDER TENSION. APPROPRIATE EYE, FACE AND HAND PROTECTION MUST BE WORN WHEN REMOVING THE BANDS TO SAFEGUARD AGAINST INJURY.

Damage claims should be filed directly with the carrier. Replacements for damaged components can be ordered by calling 1-888-TO MIRUS (1-888-866-4787).

## 2.2 Handling

	<b>NOTE</b>
	Refer to the cabinet drawings furnished with the unit for size and weight information. Typical weight and dimensions are shown in Table 1-1 and Figure 1-1.

1. Set the assembly in a level area. The HMRP equipment is packaged for forklift movement and the equipment must be protected from impact at all times. Once the equipment is in the installation location and ready to be installed, the exterior packaging material can be removed.

2. Remove HMRP from Pallet as follows:

***TO REMOVE THE HMRP FROM THE PALLET:***

- Remove the packaging material.
- Using a wrench, remove the two (2) metal angle brackets at the base of the HMRP.
- Using a wrench (3/4" SOCKET AND 1/2" SOCKET), remove both front and back kick plates with a wrench (refer to Figure 2-1).
- Using a forklift, carefully lift the HMRP off the pallet and place it on the floor. The unit will now be resting on its castors and can be rolled in to its final position.

	<p><b>CAUTION</b></p> <p>ONCE THE HMRP IS REMOVED FROM THE PALLET AND PLACED ON THE FLOOR, IT IS NOW RESTING ON ITS CASTORS AND MAY HAVE A TENDENCY TO ROLL. PROPER CARE MUST BE TAKEN TO SECURE THE HMRP AND ENSURE PERSONNEL SAFETY.</p>
---	--

	<p><b>CAUTION</b></p> <p>WITH THE LEVELING FEET UP AND THE UNIT SUPPORTED BY CASTERS ONLY, DO NOT STAND ON, OR IN, THE UNIT. THE MAIN UNIT MAY HAVE A TENDENCY TO TIP WHICH MAY RESULT IN SERIOUS INJURY. THE HMRP MUST BE RESTING ON ITS LEVELING FEET PRIOR TO WORKING ON, OR IN, THE UNIT.</p>
---	---

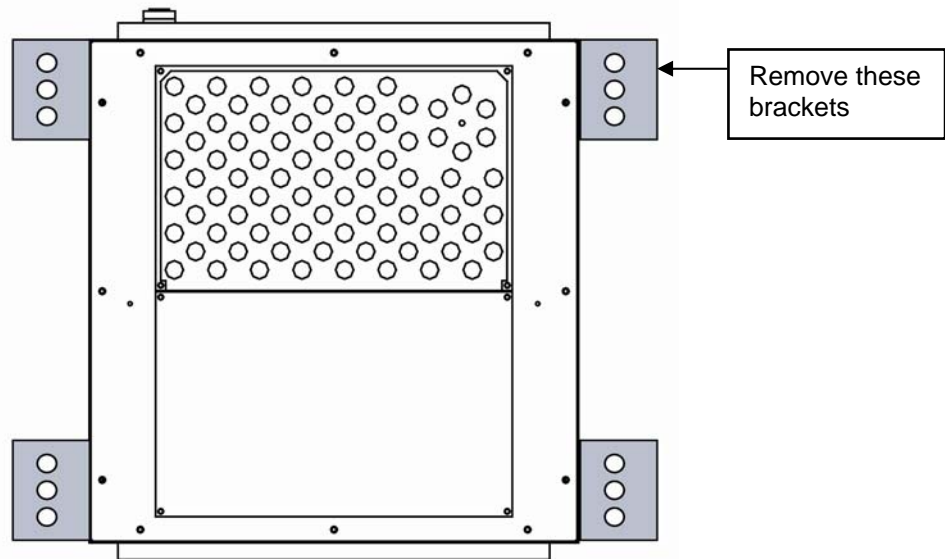

**Figure 2-1 Removing HMRP from the pallet (Top View shown)**

- Roll unit to location of installation. If possible, roll the HMRP over a couple sheets of 3/4" thick plywood on the computer room raised floor to evenly distribute the weight and protect the raised floor. Use care when positioning the unit over the floor cutout to avoid castors falling through the cutouts in the raised floor.

4. Position the HMRP over the cutouts in the floor as detailed in Figure 2-4.
5. Thirty-six inches (36") (91 cm) of front access space is recommended for the HMRP. In addition, a MINIMUM of eighteen inches (18") (46 cm) must be provided ABOVE the unit for ventilation. Check local codes and regulations for recommended clearances.
6. Floor loading should be considered to ensure that the HMRP does not exceed your raised floor load specifications. Refer to Table 1-1 and Figure 2-3 for weight and dimensional data.
7. BOTTOM CLEARANCE is required for exit of cables/conduit and/or for cooling airflow. This clearance is automatically provided by a raised floor (6 inches / 150mm minimum height). If the raised floor is not adequate to support the unit, optional floor pedestals may be used (consult factory for more information).
8. Located under each corner of the HMRP base is a leveling foot (Figure 2-2 and 2-6). Each leveling foot should be lowered to make firm contact with the floor. This procedure will help to keep the system stable and in place. Refer to Figure 2-3 for overall outer dimension of the HMRP.

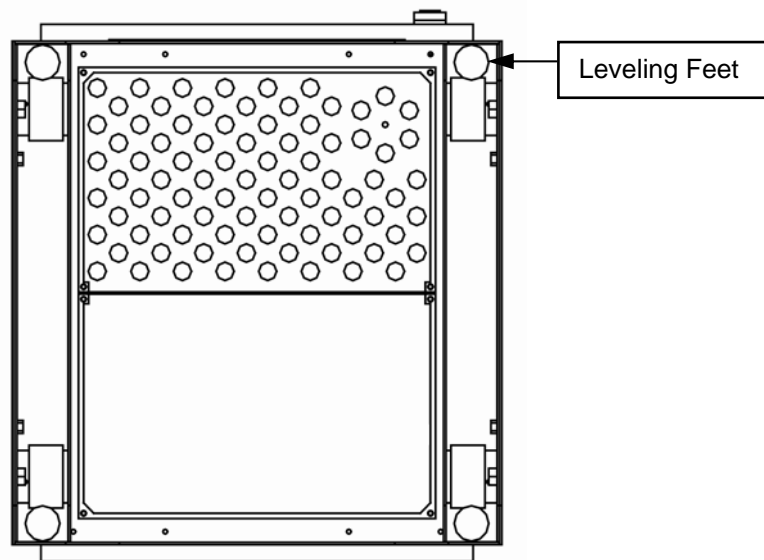

**Figure 2-2 HMRP Bottom View showing leveling feet**



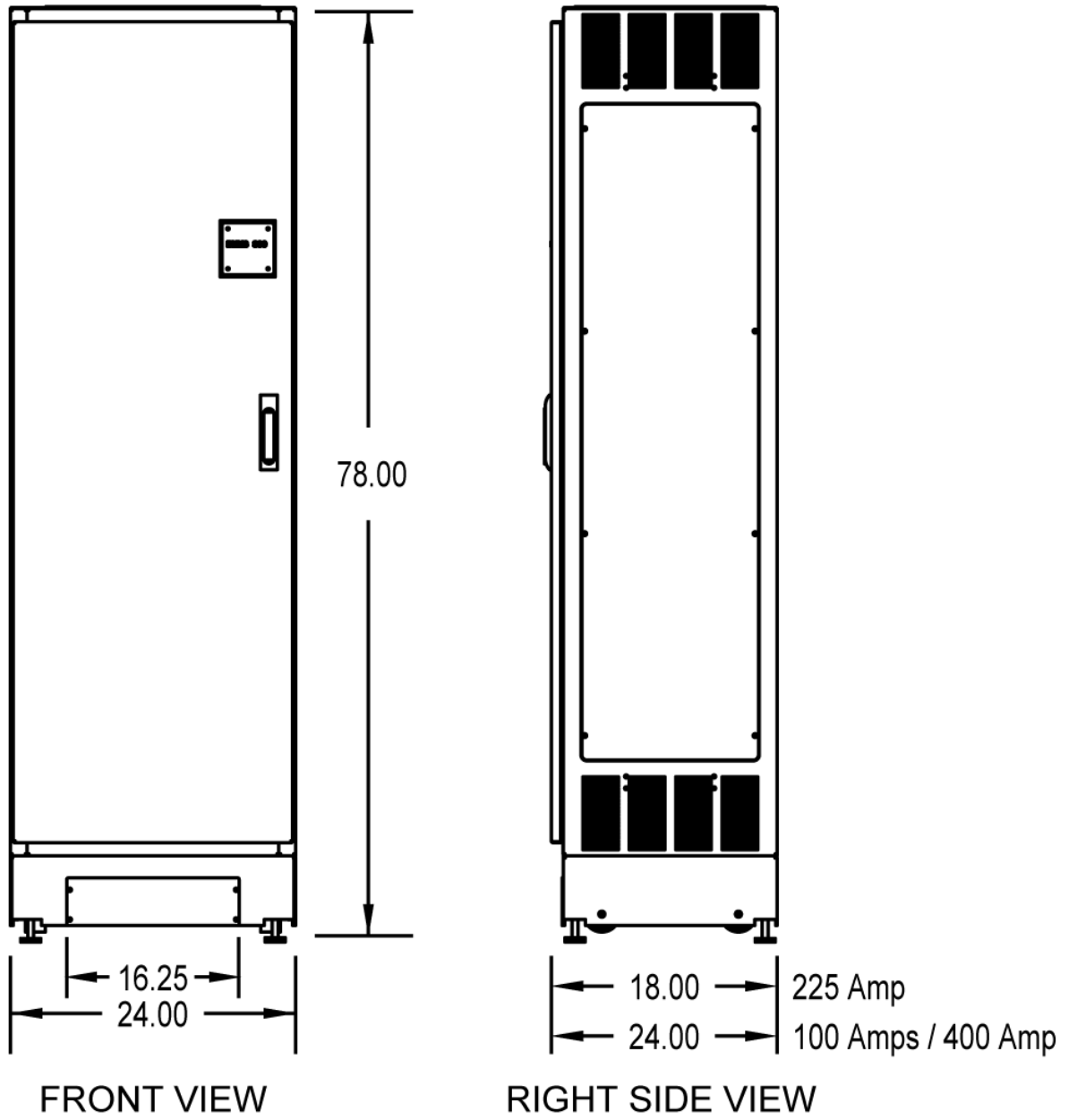

Figure 2-3 HMRP Outer Dimensions (Units = Inches)

## **2.3 Storage**

Although well packaged, this equipment is not suitable for storage outdoors. The equipment warranty will not be applicable if there is evidence of outdoor storage. If the equipment is to be stored indoors for any period of time, it should be stored with its protective packaging material in place. Protect the equipment at all times from excessive moisture, construction dirt, corrosive conditions and other contaminants. It is strongly suggested that the packaged protected equipment be stored in a climate-controlled environment of 0° to 40°C with a relative humidity of 0% to 95% (non-condensing). Do not, under any circumstances, stack other equipment on top of a HMRP equipment enclosure, whether packaged or not.

## **2.4 Prerequisite to Installation**

Installation drawings are provided with each HMRP. This section provides more information for a successful and efficient installation of the HMRP. Installation of equipment must be handled by skilled technicians and electricians familiar with the requirements of high energy electrical equipment. The installation must comply with the requirements of the National Electrical Code (NEC, ANSI/NFPA 70, latest issue) and with local codes and requirements as applicable. We strongly recommend contracting MIRUS Customer Support Services for start-up. Do not allow unqualified personnel to handle or operate the equipment.

### **Environmental considerations**

The HMRP is intended for use in an environment where control of temperature and humidity is provided.

The HMRP generates heat and exhaust air through the top ventilation louvers of the enclosure. The facility air conditioning system can maintain this room temperature within specs. Heat loss data is given in section 1-5.

### **Mechanical considerations**

#### **Cable landing**

HMRP dimensions are given in Figure 2-3. The HMRP can be mounted on a raised or solid floor. Conduit landings are provided for bottom cable entry (top cable entry is also available). A floor stand option is offered for solid floor installations if bottom cable entry is not possible.

**Floor**

For installations on a raised floor, a floor tile cut-out is required for passage of air and cables. The floor tile cut-out is shown in Figure 2-4. Floor loading must be considered when installing on a raised floor or on an upper story of a multiple-story building. Floor loading data is provided on the installation drawings supplied with your equipment. Consult a structural engineer while planning your HMRP installation. Place the HMRP so the leveling jacks are as close as possible to the corners of the tiles.

**Noise**

Consideration should be given to the specific location of the HMRP cabinet to minimize the potential for sound transmission to surrounding structures and sound reflection. It is suggested that the following installation methods be included.

1. Provide a solid foundation for mounting the HMRP.
2. Provide flexible conduit to make the connections to the HMRP.
3. Locate the HMRP as far as practically possible from areas where any sound levels are undesirable.

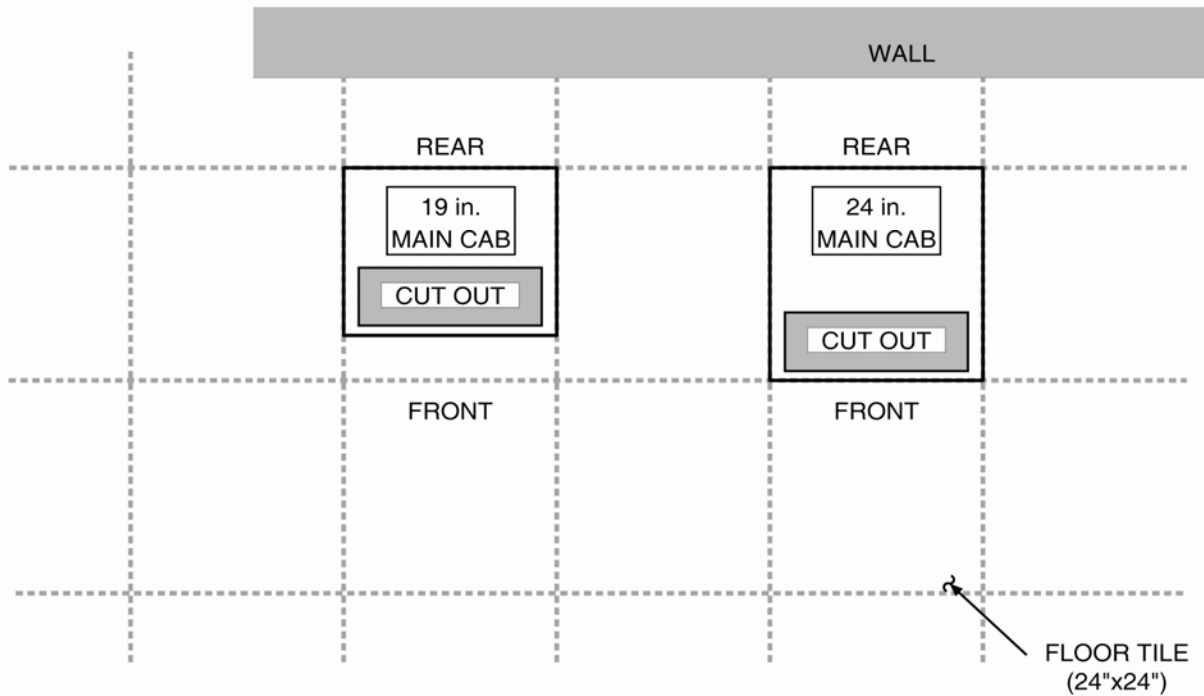

**Figure 2-4 Placement, Showing Floor Tile Cut-Outs**

	<b>NOTE</b>  The placement diagram describes the general requirements for the HMRP installation. Specific requirements are described in the installation drawings shipped with your configuration.
---	--

**Access**

The HMRP requires a minimum of 36 inches front clearance and 36 inches clearance on either the left or right side for normal maintenance. No rear clearance is required.

**Cooling**

The HMRP is convection cooled. Cooling air is drawn through the bottom section of the enclosure and exhausted through the top. The HMRP does not use forced air or air filters. Care should be taken to ensure that the air intake and exhaust areas are not obstructed for air flow.

**Electrical considerations,**

**Grounding**

An insulated grounding conductor; sized as per the National Electrical Code (NEC) or other applicable standards, must be installed as a part of the input branch circuit supplying the HMRP.

Per the NEC, article 250, the grounding conductor is to have green insulation, with or without yellow stripes and be grounded to the utility service safety grounding point (or other acceptable building ground, such as the building frame in the case of a steel frame structure), at the service equipment entrance.

All attached plug receptacles in the vicinity of the HMRP must be grounded in the same way. The conductors for those receptacle grounds are grounded to the safety ground (or other acceptable building ground, such as the building frame in the case of a steel frame structure), at the service equipment entrance.

Wiring for power and control cables is routed through the bottom of the enclosure (with an option for the top). This is shown in detail on the installation drawing for your configuration.

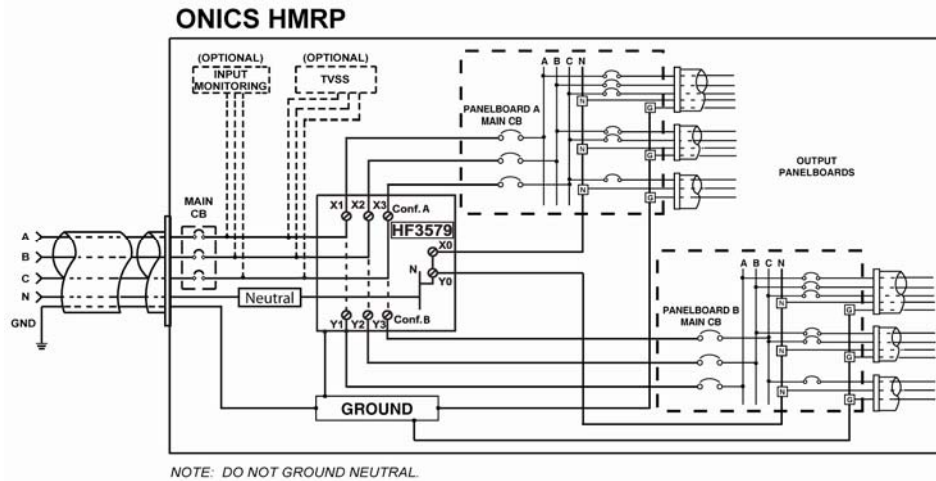

**Figure 2-5      Grounding Within The HMRP Electrical Path**

## 2.5 Installation Procedures

Installation procedures describe the general requirements for the HMRP installation. Specific requirements are described in the installation drawings shipped with your configuration.

### The steps to be followed are:

- Placement
- Output circuit breaker installation
- Connection of input power, output power, and control cables
- Start-up of the system

Installation of the HMRP equipment must be handled by skilled technicians and electricians familiar with the special requirements of high-energy electrical equipment. The installation must comply with the requirements of the National Electrical Code (NEC, ANSI/NFPA 70, latest issue) and with local codes and requirements as applicable. We strongly recommend contracting MIRUS for start-up of the HMRP. Do not allow unqualified personnel to handle or operate the equipment.

### 2.5.1 Placement

Using the mechanical prerequisite information, determine the final location for the HMRP and any applicable options, and move them into place. Lower the leveling jacks (see Figure 2-2 and 2-6) on all four corners of the enclosure, to ensure proper stability. The load must be on the leveling jacks instead of the casters.

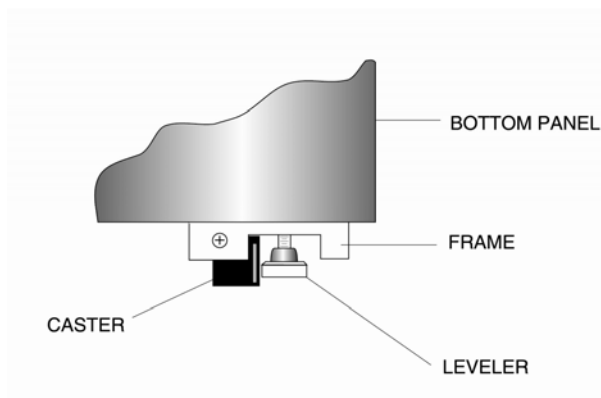



**Figure 2-6 Leveling Jacks**

**2.5.2 Connections**

	<p><b>WARNING</b></p> <p>Only qualified personnel should perform equipment installation and start-up. Lethal voltages are present during start-up procedures.</p> <p>The installation of the HMRP must comply with the requirements of ANSI/NFPA 75 and NEC ART. 645 when installed within a computer room.</p>
--	---

	<p><b>WARNING</b></p> <p>Confirm that all incoming line voltage, primary and secondary circuits are de-energized and locked out before attempting any maintenance.</p>
---	--

	<p><b>CAUTION</b></p> <p>All wiring must conform to National and Local codes. Sufficient room must be provided for routing all power cables. All signal cables must be routed separately from power cables.</p>
---	---

	<p><b>NOTE</b></p> <p>Make certain that all connections are properly torqued.</p>
---	---

1. A DEDICATED FEEDER should provide the 3-phase plus NEUTRAL input power to the unit.
2. Refer to NEC for typical conductor size data. ALL CONNECTIONS MUST COMPLY WITH NEC and other applicable codes. For proper torque values of all cable connections, refer to Table 4-2.
3. The main input feeder must ALWAYS consist of 3-phase conductors, one neutral and one ground conductor (4W+G).
4. Conductors are coded as follows:

CONDUCTOR	CODED
Phase A	A
Phase B	B
Phase C	C
Ground	GREEN or Ground Symbol
Neutral	WHITE or N

**Table 2-1 Conductor Coding**

5. A handle mechanism interlocks the main front doors of the cabinet. To open the door, pull out the bottom portion of the mechanism and turn in either direction.
6. A **KEY** will be tie wrapped to the structure inside the cabinet. After the HMRP has been installed, the cabinet can be locked to prevent unauthorized entry.
7. Located behind the main doors; the panelboard, main breaker and/or subfeed breaker trims can be removed to access internal components. To remove the trim, push and turn the ¼-turn fastener so that the arrow on its head points upward. Swing trim open. Squeeze the two levers on the hinge toward each other, turn inward and lock in place. Pull the trim toward you. To replace the trim, place movable hinge into stationary hinge, squeeze the levers, turn outward and release. Hinge pins should spring into position. Refer to Figure 2-7.

	<p><b>NOTE</b></p> <p>Prior to removing the trims from the main assembly, <b>DISCONNECT</b> the <b>GROUND STRAPS</b> connected to the trim. Once the ground straps are disconnected, the trims can be removed from their hinges and placed in a safe area, away from the unit to prevent injury or damage to the HMRP or personnel. <b>THE TRIMS MUST BE REPLACED AND GROUND STRAPS RECONNECTED</b> PRIOR TO PLACING THE HMRP IN SERVICE.</p>
---	---

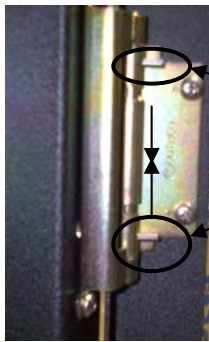

**To REMOVE Trim:**

Squeeze the upper and lower levers together, turn inward, release and lock in place. Pull trim toward you.

**To REPLACE Trim:**

Fit movable hinge into stationary hinge. Squeeze upper and lower levers together, turn outward and release levers. Hinge pins should spring back into place.

**Figure 2-7 Hinge Removal For Trims**

8. The HMRP’s main doors can be removed by opening the door, removing the hinge pin and lifting the door from the hinge. Once the doors have been removed, ensure that the hinge pins are stored in a safe location for later use.

**THE DOORS MUST BE REPLACED PRIOR TO PLACING THE HMRP IN SERVICE.**

9. All output computer power cable LOADS SHOULD BE BALANCED and terminated onto the 42-pole circuit breaker panelboards.
10. KNOCKOUTS are possible on both the TOP and BOTTOM of the HMRP for cable connection. Plates are interchangeable, 1 blank and 1 with knockouts and held in place with .25-20 screws. Power cables MUST NOT run in the vicinity of any control wiring. **Leave a minimum of 1” clearance between power cable and control wires.**
11. To avoid congestion and facilitate the addition of future loads, best practice would dictate that the knockouts toward the back of the cabinet be utilized first.
12. Refer to Figure 2-8 for location and connection of the incoming power and other electrical terminations.

**2.5.3 Connection Configuration Modes**

The HMRP is shipped with Configuration A connection mode. Configuration B can be used for improved harmonic mitigating performance where upstream harmonic distortion is low. To change to Configuration B, remove power from unit then disconnect cables from X terminals and reconnect to Y terminals as shown in Figure 2-8.

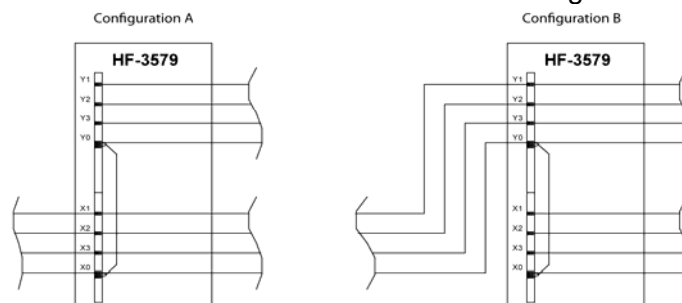

**Figure 2-8 Connection Configuration Modes (Models 225 & 400)**



## 2.5.4 Finishing the Installation

Make sure that all covers and doors are installed and closed for proper operation. Also make sure that all air intake and outlet areas are not obstructed, allowing proper air flow for equipment cooling and ventilation.

## 2.6 Startup Procedures

This section presents the procedures to be used for initial start-up of the HMRP, and the sequence to be followed any time that the system is restarted after having been shut completely down with no power applied to the system.

### 2.6.1 Checks Before Startup

Before starting the HMRP, read this HMRP Owner's Manual thoroughly. Be certain that you fully understand the operation of the indicators, controls, and operational sequences.

Before starting the HMRP, make sure of the following:

- Upstream power circuit breaker is open.
- Power cables have been properly connected to the input circuit breaker.
- Voltage connected to the HMRP matches the HMRP nameplate and model number.
- Equipment has been properly grounded.
- All power and control connections are properly made and are tight.
- Intake and exhaust ventilation areas have no obstructions that might impair proper air flow.

### 2.6.2 Initial Startup

After verifying the information presented in Section 2.6.1:

- Close the upstream circuit breaker.
- Close the main circuit breaker CB1.
- Close the main panelboard circuit breaker.
- Close individual output circuit breakers as required.

### 2.6.3 Checks After Startup

Normal operation of the HMRP should be verified immediately after the initial start-up has been performed. At the minimum, use the circuit monitor, if installed, to verify proper readings from all circuits.

Even with no load connected to the HMRP, some current may appear on the input phase conductors and neutral after start-up. This is the result of the HF3579 Filter attracting some harmonics from the upstream distribution system. As long as this current is not too excessive, it is perfectly normal operation.

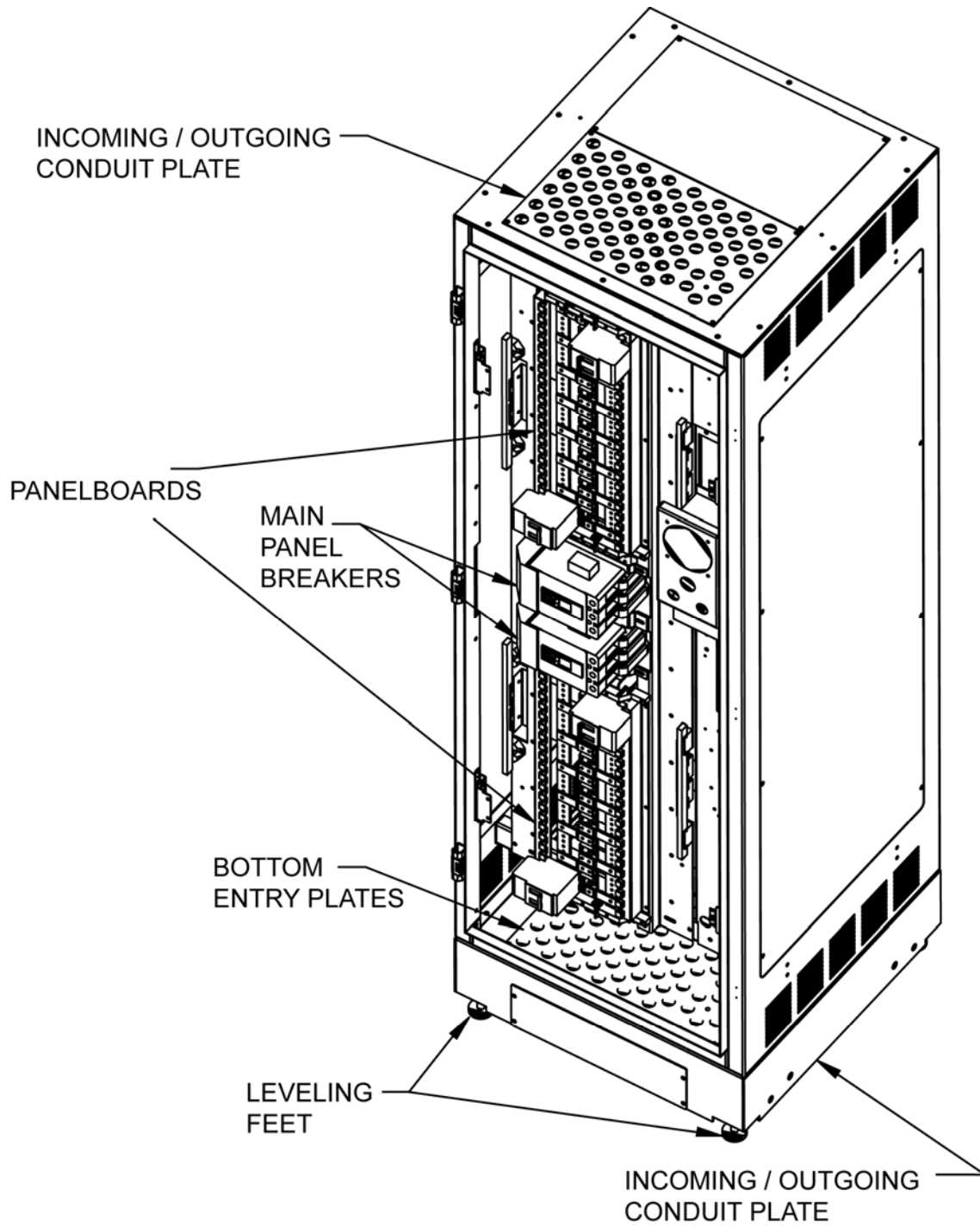

Figure 2-9

HMRP Layout

**ELECTRICAL CHECKOUT INSTRUCTIONS****WARNING**

Always be sure that all incoming line voltage, primary and secondary circuits are de-energized and locked out before attempting any maintenance.

1. Confirm that proper clearances for maintenance access and ventilation have been maintained. There should be a minimum of 18" clearance ABOVE the HMRP and 36 inches on either the left or right side of the unit. Refer to local codes and regulations for clearances in front of the HMRP.
2. Remove front door and interior trim and sidepanels as required. All ground straps must be disconnected from the trims prior to removing them off the enclosure.
3. Confirm that all main, secondary and branch circuit breakers are in the 'OFF' position.
4. Inspect all wire and conductor insulation for damage.
5. Check all filter and breaker connections for tightness and retorque if necessary.
6. Check all terminal block connections for tightness and retorque if necessary as per Table 3.
7. Verify that all cables meet or exceed conductor sizes as per NEC Requirements.
8. Remove any foreign objects from the interior of the unit. Intake and exhaust air screens must be clean and free of obstruction.
9. NOTE: AIR PASSAGES ABOVE, BELOW, IN FRONT AND BEHIND THE HARMONIC FILTER MUST BE CLEAR AND FREE FROM DEBRIS.
10. Ensure that the cutouts in the floor are as per Figure 2-4.
11. Verify input connections to the main input breaker(s), as well as, the equipment grounding and grounding electrode conductors.
12. Turn ON the building input power to the HMRP.
13. Check the phase rotation at the main input breaker(s). Phase rotation should be A,B,C, left-to-right.
14. Verify and record the INPUT voltages on the main circuit breaker.

## ONICS™ Harmonic Mitigating Remote Panelboards (HMRP)

---

Breaker	PHASE VOLTAGES					
	A-B	B-C	C-A	A-N	B-N	C-N
1						
2						
3						
4						

- 15. If the input voltage is incorrect, verify input voltage.
- 16. Turn on the HMRP's main incoming circuit breaker Breaker(s). If the breaker trips within one (1) minute, contact Mirus International Inc. or a factory representative for assistance.
- 17. Check the phase rotation at the line side of the terminals of the panelboard main breaker(s) and any subfeed circuit breakers. The rotation should be A,B,C, top-to-bottom (note that the main panelboard and subfeed breakers have been rotated 90 degrees, counter-clockwise)

	<b>NOTE</b>  Please note that the control circuit may be energized when the main breaker is in the tripped or off position.
---	---

# 3

# Maintenance

## 3.0 Scope

This section describes maintenance of the HMRP, including preventive maintenance, troubleshooting, and information about replacement parts.

## 3.1 Preventive Maintenance

The following preventive maintenance routines should be considered the minimum requirements; your installation and site may require additional preventive maintenance to assure optimal performance from HMRP and associated equipment. These routines should be performed twice a year.

The technician or electrician performing preventive maintenance on the HMRP must read this manual thoroughly and be familiar with the indicators, controls, and operation of the equipment.

	<p><b>IMPORTANT</b></p> <p>Isolate and de-energize the equipment for all maintenance operations.</p>
--	--

- a. Ensure that the equipment is clean and free of loose dust, dirt, and debris. The exterior of the enclosures can be cleaned with a mild solution of soap and water, lightly applied with a lint-free cloth.
- b. Inspect the air intake and exhaust plates and clean as required. Verify that air flows freely through the equipment. Clean the air intake and exhaust plates, and the enclosure interior, with a vacuum cleaner.

	<p><b>IMPORTANT</b></p> <p>Operation of the remote circuit breakers will cause power to be removed if it is present and will cause power to be applied if it is not. Make sure that all loads are prepared to have power removed (all critical circuits have been shut down), or circuits are safe for power application (no maintenance procedures are being conducted and downstream circuit breakers are open and tagged) before remote operation of the circuit breakers.</p>
---	---

- c. Remotely operate all circuit breakers to verify that circuit breakers function properly.
- d. Verify that all system monitoring functions operate properly.

### **3.2 Troubleshooting**

The following is a list of the most frequent problems, their most likely cause, and the possible solutions in the form of actions to be taken. In the event that the suggested solution does not solve the problem, call MIRUS International Inc. Customer Support Services for assistance.

#### **A. HMRP has no input power**

Cause #1: No building power to the HMRP  
Action: Restore building power  
Have a qualified technician check the wiring continuity between the HMRP and the building input power panel.  
Refer to section 2 for connections.

#### **B. Specific output circuit(s) have no power**

Cause #1: Associated output circuit breaker(s) are OFF.  
Action: Reset the circuit breaker(s).  
Cause #2: The wiring between the circuit breaker(s) and the equipment(s) is faulty.  
Action: Have a qualified technician check for wiring continuity and correct phase sequence between the circuit breaker(s) and the equipment(s).  
Cause #3: The equipment associated with the circuit breaker is operating above the rated load.  
Action: Schedule a load check of the equipment with a qualified technician; adjust for load balance if possible.  
Cause #4: Defective circuit breaker.  
Action: Replace defective circuit breaker.

**C. No output from the HMRP, but the monitor is active.**

- Cause #1: Main input circuit breaker CB1 is off.  
 Action #1: Record which alarm indications are active.  
 Action #2: Reset alarm(s) and clear external signal.  
 Action #3: Check the alarm history display for reason the main input circuit breaker tripped:
- a. Manual trip ... due to an emergency power off (EPO) button being pushed.
  - b. An "alarm shut-down" has occurred; determine the cause and take corrective action before resetting the main input circuit breaker CB1.
  - c. Automatic trip ... an external signal was received from the building wiring via the alarm interface instructing the HMRP to shunt-trip.
  - d. Output overload ... schedule a load check of the HMRP by a qualified technician.
  - e. Defective circuit breaker ... replace the circuit breaker.
  - f. Short circuit internal to the HMRP ... Troubleshoot the HMRP or call MIRUS International Inc. Customer Support Services.
- Cause #2: Output power fuse(s) blown  
 Action: Replace fuse(s)

**D. Output from the HMRP, but the monitor is not active.**

- Cause: Control power fuse(s) blown.  
 Action: Replace fuse(s)

**E. Over/under voltage.**

- Cause #1: Upstream UPS or power conditioner is defective.  
 Action: Correct problem at the power source.
- Cause #2: Voltage drop due to distance or excessive load on mains.  
 Action: Disconnect power and adjust transformer taps.

	<p><b>IMPORTANT</b></p> <p>Before changing transformer taps, verify that the over/under voltage condition is constant. Changing transformer taps will increase or decrease the ratio of input voltage to output voltage.</p>
---	--





## 4 APPENDIX - SPECIFICATIONS / DATA

### 4.0 HMRP™ Specifications / Data

Size	Width		Depth		Height		Weight	
	IN	CM	IN	CM	IN	CM	LB	KG
<b>HMRP-225</b>	24	61	18	46	78	198	750	340
<b>HMRP-400</b>	24	61	24	61	78	198	1070	485
<b>HMRP-100</b>	24	61	24	61	78	198	900	408

*Table 4-1 Weight and dimensional data*

Wire Size AWG	No. of Wires	MAIN AND SUBFEED BREAKERS			
		TIGHTENING TORQUES FOR WIRE PRESSURE SCREW (Lb. In.)			
		Slotted Head Screw		Socket Head Screw	
		Over ¼" Slot Length	¼" and Less Slot Length	3/16" Socket	5/32" Socket
14 – 10	1	35	20		
8	1	40	25		
6	1	45	35	120	100
4	1	45	35	120	100
3	1	50	35	120	100
2	1	50	40	120	100
1	1	50		120	100
1/0	1	50		120	100
2/0	1	50		120	100
3/0	1	50		120	100
4/0	1	50		120	100

Please refer to additional instruction leaflets shipped with the equipment.

*Table 4-2 Main and Subfeed Breaker Torque specifications*

Branch Breakers		
Wire Size AWG	No. Of Wires	Torque (Lb. In.)
14 – 10	1	20
8	1	25
6 – 4	1	27
3 – 1/0	1	45

*Table 4-3 Branch Breaker Torque specifications*

#### **4.1 HMRP™ Breaker & Fuse Ratings**

A replacement Fuse Rating chart is supplied with each unit. It is located on the inside surface of the Main Enclosure door.

<b>Model</b>	<b>225</b>	<b>400</b>	<b>100</b>
Main Breaker - CB1	225A, 240VAC	400A, 240VAC	125A, 600VAC
Panelboards – CBA, CBB	125A, 240VAC	225A, 240VAC	70A, 600VAC
FUSE - F1	3A, 600VAC	3A, 600VAC	3A, 600VAC
FUSE - F2, F3, F4	1/10A, 600VAC	1/10A, 600VAC	1A, 600VAC
FUSE - F5, F6, F7	15A, 600VAC	15A, 600VAC	15A, 600VAC

**Table 4-4 Breaker and Fuse Ratings**













**MIRUS International Inc.**  
**31 Sun Pac Blvd., Brampton, Ontario Canada L6S 5P6**  
**1 - 888 - TO - MIRUS (1 - 888 - 866 - 4787)**  
**Tel: (905) 494-1120**  
**Fax: (905) 494-1140**  
**E-Mail: [mirus@mirusinternational.com](mailto:mirus@mirusinternational.com)**  
**Website: [www.mirusinternational.com](http://www.mirusinternational.com)**