

THE LINEATOR™  
ADVANCED UNIVERSAL HARMONIC FILTER (AUHF)



---

# IMPORTANT SAFETY INSTRUCTION

**SAVE THESE INSTRUCTIONS** - This manual contains important instructions for the Lineator™ AUHF that must be followed during installation, operation, and maintenance of the Lineator™ AUHF and its auxiliary equipment.



## WARNING

OPENING ENCLOSURES EXPOSES HAZARDOUS VOLTAGES.  
ALWAYS REFER SERVICE TO QUALIFIED PERSONNEL ONLY.



## WARNING

As standards, specifications, and designs are subject to change, please ask for confirmation of the information given in this publication.

This manual is a controlled document; pages should not individually be removed from this document.

**THE LINEATOR™**  
**ADVANCED UNIVERSAL HARMONIC FILTER (AUHF)**

**INSTALLATION, OPERATION AND  
MAINTENANCE GUIDE**

AUHF-M001-A10  
26-May-2014

---

**MIRUS International Inc.**  
31 Sun Pac Blvd.  
Brampton, Ontario  
Canada L6S 5P6

1 - 888 - TO - MIRUS (1 - 888 - 866 - 4787)  
Tel: (905) 494-1120  
Fax: (905) 494-1140  
E-Mail: [mirus@mirusinternational.com](mailto:mirus@mirusinternational.com)  
Website: [www.mirusinternational.com](http://www.mirusinternational.com)

# The Lineator™ Advanced Universal Harmonic Filter (AUHF) 5 to 3500 HP Owner's Manual

---

## Warranty

1. MIRUS International Inc. ("MIRUS") warrants to the end-user (the "Customer") of the LINEATOR™ Advanced Universal Harmonic Filter ("AUHF") as follows:
    - (a) The LINEATOR™ AUHF will be free from defects in materials and workmanship under normal use and service for a period of 3 years from the date of shipment; and
    - (b) The LINEATOR™ AUHF will perform as advertised to reduce harmonic distortion caused by AC Variable Speed Drives and other non-linear loads equipped with 3-phase, 6-pulse, diode bridge rectifiers. A properly selected and installed LINEATOR™ will:
      - (i) Reduce Current Total Harmonic Distortion (ITHD), measured at the LINEATOR™ input terminals at full load, to:
        - (1.) < 8% when background voltage distortion is < 5% and voltage imbalance is < 3%
        - (2.) < 5% when short circuit ratio (Isc/IL), as defined by IEEE Std 519, is < 20 and when background voltage distortion is < 0.5% and voltage imbalance is < 1%
      - (ii) Reduce Current Total Demand Distortion (ITDD), measured at the LINEATOR™ input terminals over its entire operating range, to levels defined in Item 1 above. ITDD is defined as the measured ITHD multiplied by the ratio of measured RMS current to full load current (peak demand current) of the LINEATOR™.
      - (iii) Minimize the contribution to Voltage Harmonic Distortion of all VSD's equipped with the LINEATOR™ to < 5% total and < 3% for individual harmonics, as defined by IEEE Std 519-1992.
      - (iv) NOT become overloaded by other upstream harmonic sources.
      - (v) NOT resonate with other power system components.
      - (vi) NOT have compatibility problems with engine generator sets properly sized for the load.
  2. **Limitation:** The foregoing warranties shall not apply and shall be void if the LINEATOR™ AUHF has been subject to misuse, abuse, accident, disaster, or has been operated contrary to MIRUS' instructions relating to installation, maintenance, use or operation.
  3. **Exclusive Remedy:** If the LINEATOR™ AUHF does not conform with the warranties set out above, the Customer must notify MIRUS of the defective unit within the applicable warranty period and obtain a written return material authorization (an "RMA") from MIRUS. The Customer must return the defective unit to MIRUS, freight prepaid, within sixty (60) days of receipt of the RMA and must include a copy of MIRUS' paid invoice for the defective unit and a description of the defective unit's failure to conform. If MIRUS agrees that the returned unit is defective, MIRUS' entire obligation and liability shall be, in MIRUS' sole discretion, to repair or replace the defective unit or give a full refund of the purchase price to the Customer.

THE FOREGOING IS THE CUSTOMER'S SOLE AND EXCLUSIVE REMEDY FOR BREACH OF WARRANTY BY MIRUS WITH RESPECT TO THE LINEATOR™ AUHF.
  4. **Replacement or Repaired Product Warranty:** Any repaired or replaced LINEATOR™ AUHF shall be warranted as set forth herein for the remainder of the applicable warranty period of the original unit or for three (3) months, whichever is greater.
- 

## Service and Factory Repair - Call 1 - 888 - TO - MIRUS (1 - 888 - 866 - 4787)

Direct questions about the operation, repair, or servicing of this equipment to MIRUS International Inc. Customer Support Services. Include the part number, assembly number, and serial number of the unit in any correspondence. Should you require factory service for your equipment, contact MIRUS International Inc. Customer Support Services and obtain a Return Materials Authorization (RMA) prior to shipping your unit. Never ship equipment to MIRUS International Inc. without first obtaining an RMA.

---

## Proprietary Rights Statement

The information in this manual is the property of MIRUS International Inc., and represents a proprietary article in which MIRUS International Inc., retains any and all patent rights, including exclusive rights of use and/or manufacture and/or sale. Possession of this information does not convey any permission to reproduce, print, or manufacture the article or articles shown herein. Such permission may be granted only by specific written authorization, signed by an officer of MIRUS International Inc.

LINEATOR™ is a trademark of MIRUS International Inc. Other trademarks that may be used herein are owned by their respective companies and are referred to in an editorial fashion only.

---

## Revision History

Copyright ©	All rights reserved. Printed in Canada
Revision: A10	New Release 2014/05/26

---

# Contents

## Introduction

Section	Description	Page
1.0	General Information .....	1
1.1	General .....	1
2.0	Product Description and Application .....	1
2.1	Description .....	1
2.2	Harmonics from other Sources .....	1
2.3	System Resonance .....	1
2.4	Leading Power Factor .....	1
2.5	Harmonic Distortion Reduction .....	1
2.6	Isolation Transformers .....	1
3.0	Installation .....	2
3.1	Location .....	2
3.2	Inspection and Energization .....	2
3.3	Handling .....	2
3.4	Grounding .....	3
4.0	Storage .....	3
5.0	Maintenance .....	3
5.1	Periodic Inspection and Maintenance .....	3
5.2	Cleaning .....	4
5.3	Drying of Core and Coil Assembly .....	4
6.0	Operation .....	4
6.1	Effect of Humidity .....	4
6.2	Loading .....	4
7.0	Technical Data .....	5
7.1	General Specifications .....	5
7.2	Connection Diagrams .....	5
7.3	Lineator Rating Table .....	6
7.4	Recommended Circuit Breaker of Fuse Protection.....	8
7.5	Lineator Type Operational Curve .....	9
7.6	Enclosure Dimensions .....	10
8.0	Troubleshooting Guide .....	11



## 1.0 General Information

### 1.1 General

Lineators™ are manufactured to provide optimum performance for a lifetime of uninterrupted service. Careful attention to the following instructions is recommended for safe and reliable operation.

Installation, operation and maintenance of Lineators™ should be performed by authorized persons, familiar with electrical apparatus and the potential hazards involved.

	<p><b>WARNING</b></p> <p><i>Danger! There is the potential of electric shock whenever working in or around electrical equipment such as the Lineator™. Power must be shut off before any work is conducted on a Lineator™.</i></p>
---	--

As with any electrical device, Lineators™ must be installed according to the requirements of the national and local electrical codes.

## 2.0 Product Description and Application

### 2.1 Description

The Lineator™ is a purely passive device consisting of a revolutionary new inductor combined with a relatively small capacitor bank. Its innovative design achieves cancellation of all the major harmonic currents generated by VSD's and other similar 3-ph, 6-pulse rectifier loads (resulting in THID of < 8% and often as low as 5%). Although referred to as a filter, the Lineator™ exhibits none of the problems that plague conventional filters.

### 2.2 Harmonics from other Sources

The Lineator™ will present a high impedance to line side harmonics, thus eliminating the possibility of attracting harmonics from upstream non-linear loads.

### 2.3 System Resonance

The natural resonance frequency of the Lineator™ is below that of any predominant harmonic, therefore inadvertent resonance is avoided.

### 2.4 Leading Power Factor

The leading PF of the Lineator™ at light loads consists of very low capacitive reactance < 20% of rated kVA. Switching out capacitors under no load conditions is not necessary when using the Lineator™.

### 2.5 Harmonic Distortion Reduction

The Lineator™ will reduce current distortion to < 8% and typically achieves near 5% THID when operating near full load.

### 2.6 Isolation Transformers

The high let-through impedance of the Lineator™ will provide many of the same benefits as the drive isolation transformer, while also dramatically reducing the harmonics injected into the power system by the drive. It accomplishes this in a much smaller footprint, so when there is no need for voltage transformation, the use of the Lineator™ eliminates the need for a drive isolation transformer. And when voltage transformation is required, the isolation transformer will not require a K-factor rating.

## 3.0 Installation

### 3.1 Location

Location of the Lineator™ should be made with consideration given to accessibility, ventilation and atmospheric conditions. Installation locations should be free of contaminants including dust, fertilizer, excessive moisture, corrosive gases, flammable materials or chemical fumes. Filtered air may be considered to reduce maintenance where air born contaminants are a problem.

Sufficient clearances from walls and other obstructions should be provided to permit unrestricted opening of hinged and removable doors, covers and panels for the purpose of wiring terminations, inspection, maintenance and testing. Also, **proper ventilation requires at least 6 in. (155mm) clearance** at all ventilation openings, with the exception of the rear face of wall mountable enclosures such as the SU1, SU2, SU3 and SU4 type enclosures. Ambient temperature must not exceed 104 Deg F (40 Deg C). In enclosed rooms, minimum air circulation of 100 ft<sup>3</sup>/min per kilowatt of loss should be provided.

**Do not stack Lineators or install above other heat source equipment.**

Enclosures are designed in accordance with NEMA and UL standards and can allow for installation in various environments. Standard enclosures for the Lineator™ are NEMA3R rated.

For derating factors which apply to installations above 3000ft [1000m] refer to Section 7.5 Lineator Type Operational Curve.

### 3.2 Inspection and Energization

Upon receipt of shipment, the Lineator™ should be inspected for any damage incurred during shipment. Before energization an internal inspection should be conducted with emphasis on loose or broken connections, damaged or displaced parts, cracked insulators, dirt or foreign material, or evidence of moisture. While servicing the Lineator, all relevant safety standards must be followed, including all applicable electrical codes and NFPA 70E – Standard for Electrical Safety in the Workplace.

#### 3.2.1 Before Energization

- Verify that the Lineator external feeder circuit breaker is in the OFF/OPEN position so that unit is de-energized.

- Check all bolts, nuts, screws, and connections for tightness and inspect for broken or damaged components or cables.
- Clean, vacuum, and clear interior of Lineator enclosure of any extra hardware and debris.
- Verify proper three-phase wiring of system power wires, ground, and feeder breaker.
- Check all capacitors for swelling, leaking, or extruded vents; replace if necessary. Verify all fuses for integrity and rating.
- If Lineator has been sitting idle for 6 months or longer before first energization, it is recommended that the maintenance procedure described in 5.0 is performed prior to startup.

#### 3.2.2 Initial Lineator start-up and run

- If test measurements are to be taken, connect any test equipment before energization.
- It is recommended that any test instruments be connected such that all enclosure panels can be installed properly and Lineator can be fully enclosed. Consider using meters with remote wireless displays if possible.
- When energizing, use appropriate personal protection equipment (PPE) and other precautions as required by NFPA 70E.

### 3.3 Handling

The Lineator™ should be thoroughly protected against the entrance of dust, rain or snow when handled outdoors.

When lifting the Lineator™, the lifting cables should be held apart by a spreader to avoid bending the lifting lugs or other parts of the structure. To access the lifting lugs, remove the top enclosure cover. The Lineator™ may be skidded or moved on rollers but care must be taken not to damage the base or tip it over. When rollers are used under larger units, skids must be used to distribute the stress over the base.

After the Lineator™ is placed in permanent position, shipping braces should be removed and shipping bolts, if present, should be loosened.

**Where isolation pads have been included, the bolt should be loosened until the spring washer has been relaxed before putting into service.** This will reduce noise resulting from the Lineator's™ natural vibration.



### 3.4 Grounding

Consideration must be given to equipment grounding (case and core) and must be made in accordance with all applicable electrical codes.

## 4.0 Storage

Condensation and moisture absorption must be prevented during storage. The Lineator™ must be stored in a warm, dry location. Ventilation openings should be covered to keep out dust. If outdoor storage cannot be avoided, the Lineator™ must be protected to prevent entrance of water, moisture and foreign material.

## 5.0 Maintenance

**Caution:** Before entering or working on the Lineator™, it should be de-energized, properly grounded and isolated. Only qualified service technicians should be allowed to maintain the filter. While servicing the Lineator, all relevant safety standards must be followed, including all applicable electrical codes and NFPA 70E – Standard for Electrical Safety in the Workplace.

### 5.1 Periodic Inspection and Maintenance

The Lineator™ has no moving or active parts and therefore requires only minimal periodic maintenance when installed in a clean and well ventilated environment. Annual maintenance is recommended. This should include:

- 5.1.1 Visual inspection for evidence of loose connections, dirt, moisture, rusting, corrosion, and deterioration of the insulation, varnish or paint. Observations should be made for signs of overheating and overvoltage creeping. Corrective measures should be taken as necessary.
- 5.1.2 For early detection of any developing hotspots, an infrared scan can be performed while the Lineator™ is operating under its heaviest load condition.
- 5.1.3 Lineator™ capacitors are equipped with an internal ‘Tear-Off’ fuse pressure interrupter to prevent explosive failure. At the end of its service life, pressure within a capacitor will build due to the release of gases as its dielectrics breakdown. The covers on the cans are designed to expand or bulge and Tear-Off the internal fuse as this pressure builds. Capacitors should be inspected regularly and replaced when found to have an expanded cover.

- 5.1.4 Even though they may appear fine physically, capacitors may require replacement if their capacitance value has degraded significantly. With the Lineator de-energized and locked out, pull capacitor fuses and measure the capacitance of each capacitor. If this value indicates a drop in capacitance of more than 5%, the capacitor should be replaced.

**Caution:** Ensure that power to the Lineator™ has been turned off and safely isolated before replacing failed capacitors.

- 5.1.5 Most Lineators™ are also equipped with capacitor fuses. Capacitor fuses are intended to provide additional protection against overloading of the capacitors and upstream reactor. A blown fuse can be detected by checking for illumination of the blown fuse indicator when this option has been purchased or by testing for conductivity. If the blown fuse indicator is on or the fuse is open, it should be replaced.

**Caution:** Ensure that power to the Lineator™ has been turned off and safely isolated before replacing blown fuses.

- 5.1.6 Measuring the current in each of the 3 phases of the capacitor circuit can be another method of determining the condition of the capacitors. The capacitors can be assumed to be in good operating condition when all 3 phases carry approximately the same amount of load current. Measurements should be taken at the input to the capacitor distribution block and can be done at any loading condition. Phase currents that are imbalanced by more than 10%, indicate a capacitor failure or blown fuse. When the filter capacitor bank has been connected in a wye configuration (ie. two jumpers create a common point on each set of three capacitors), locating the problem capacitor(s) can be achieved by measuring the voltage between the common neutral point of each set to ground. If the voltage difference is greater than 10V, at least one of the capacitors in that set has failed or has a blown fuse. Testing should be conducted annually or whenever the unit seems to be operating in an abnormal manner.

- 5.1.7 The Lineator™ is capable of continued operation with some failed capacitors or blown capacitor fuses. Harmonic mitigation performance will be sacrificed however, so it is recommended that all failed capacitors or blown capacitor fuses be replaced as soon as is practically possible after detection.

### 5.2 Cleaning

Excessive accumulations of dirt on the reactor windings or insulators and capacitor terminals should be removed to permit free circulation of air and to guard against the possibility of insulation breakdown. Particular attention should be given to cleaning the top and bottom ends of the winding assemblies and to cleaning out ventilating ducts. Windings should be lightly cleaned by the use of a vacuum cleaner. If necessary a blower or compressed air may be used but pressure should not exceed 25 psi. Lead supports, tap changers and terminal boards, bushings, and other major insulating surfaces should be brushed or wiped with a dry cloth. The use of liquid cleaners is not recommended due to deteriorating effects on most insulating materials.

### 5.3 Drying of Core and Coil Assembly

**Caution:** Constant attention during the drying process is recommended.

When it is necessary to dry a Lineator™ reactor before installation or after an extended shutdown under relatively high humidity conditions, internal and/or external heating methods can be used. (See ANSI/IEEE C57.94-1982 for a description of these methods).

It is important that most of the heated air pass through the winding ducts and not around the sides. Good ventilation is essential in order that condensation not take place in the reactor itself or inside the case. A sufficient quantity of air should be used to assure approximately equal inlet and outlet temperatures.

During the drying process, ambient air temperature should not exceed 45°C [113°F].

## 6.0 Operation

**Caution:** Do not remove covers, shrouds, panels, or any enclosure parts while the Lineator™ is energized.

### 6.1 Effect of Humidity

While the Lineator™ is energized, humidity conditions are generally not important since the heat from the reactor will prevent condensation. If a shutdown exceeding 24 hours occurs during a period of high humidity that could cause condensation within the reactor, precautions should be taken. Small strip heaters may be energized in the bottom of the unit to maintain the temperature of the unit a few degrees above that of the outside air. If such precautions are not taken the unit should be inspected for evidence of moisture and insulation resistance checked. If necessary, dry as described in Maintenance section above.

### 6.2 Loading

A Lineator™ should only be loaded in accordance with its nameplate rating.

## 7.0 Technical Data

### 7.1 General Specifications

**Voltages**

All standard voltages up to 690V

**Frequency**

60Hz and optional 50Hz

**Overload Capability**

150% for 60 seconds every 10 minutes

**Harmonics Treated**

5<sup>th</sup>, 7<sup>th</sup>, 11<sup>th</sup>, 13<sup>th</sup>, ...

**K-Factor Suitability**

Up to 20

**Input K-Factor**

Reduced to < 1.5

**Input Current Distortion**

< 8% @ Full Load

**Maximum Capacitive Reactive Current**

< 15% of rated current

**Efficiency**

> 99%

**Elevation**

≤ 3300ft [1000m] above sea level

**Ambient Temperature**

≤ 104 Deg F [40 Deg C]

**Ventilation**

Convection air cooled

**Winding Material**

Copper

**Insulating Varnish Impregnation**

Polyester Resin

**Enclosure**

Type: NEMA-3R (Type-3R)

Paint: Polyester powder coated

Colour: ANSI 61 Grey

Wall Mtg. Capability: 5 to 200HP

### 7.2 Connection Diagrams

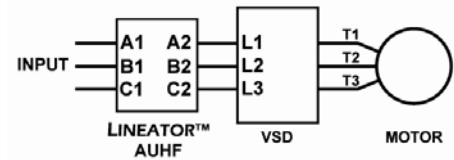

Typical VSD System with Lineator™

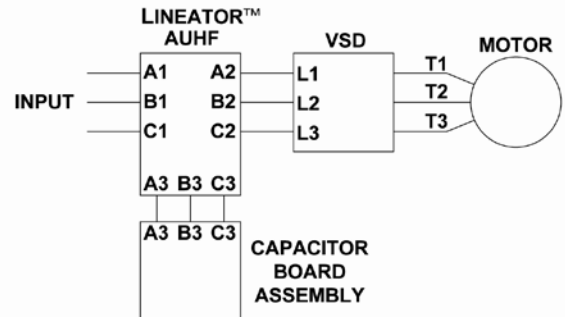

Typical VSD System – Lineator™ and capacitor board shipped loose.

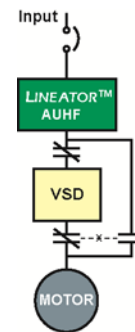

Lineator™ configuration in VSD System with Bypass. This configuration will provide Soft-Start functionality.

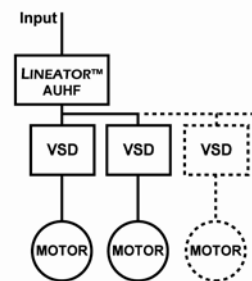

Lineator™ with Multiple VSD System

7.3 Lineator Rating Table

Motor Size		Lineator Rating (3-Phase)				480V (60Hz)				600V (60Hz), 690V (50-60Hz)			
HP	kW	Input Amps			Output kW	Standard Enclosure		Enhanced Enclosure		Standard Enclosure		Enhanced Enclosure	
		460/ 480V 60Hz	575/ 600V 60Hz	660/ 690V 50/60Hz		Case Style	Weight lbs [kg] <sup>(1)</sup>	Case Style	Weight lbs [kg] <sup>(1)</sup>	Case Style	Weight lbs [kg] <sup>(1)</sup>	Case Style	Weight lbs [kg] <sup>(1)</sup>
5	4	7	5	5	4.5	SU1	58 [26]	SU1-E	68 [31]	SU1	57 [26]	SU1-E	67 [30]
7.5	5.5	9	7	6	6.3		67 [30]		77 [35]		67 [30]		77 [35]
10	7.5	12	10	8	8.5		78 [35]		88 [40]		77 [35]		87 [39]
15	11	17	14	12	13		90 [41]		100 [45]		86 [39]		96 [44]
20	15	23	18	16	17	SU2	118 [54]	SU2-E	128 [58]	SU2	98 [45]	SU2-E	128 [58]
25	18.5	29	23	20	21		130 [59]		140 [64]		125 [57]		135 [61]
30	22	34	28	24	25		142 [65]		152 [69]		137 [62]		147 [67]
40	30	46	37	32	34		154 [70]		164 [74]		149 [68]		159 [72]
50	37.5	57	45	40	42	SU3	186 [84]	SU3-E	196 [89]	SU3	184 [83]	SU3-E	196 [89]
60	45	69	55	48	51		218 [99]		228 [103]		206 [94]		216 [98]
75	55	85	68	59	63		304 [138]		314 [142]		298 [135]		308 [140]
100	75	113	90	79	84		323 [147]		333 [151]		315 [143]		325 [147]
125	90	141	112	98	104	SU4	345 [156]	SU4-E	419 [191]	SU4	345 [156]	SU4-E	419 [191]
150	110	169	135	118	125		365 [166]		439 [200]		365 [166]		439 [200]
200	150	226	180	158	168		415 [189]		489 [222]		415 [189]		489 [222]
250	185	281	225	196	209		578 [262]		640 [290]		578 [262]		640 [290]
300	200	337	270	235	251	MT3	585 [266]	MT3-E	695 [316]	MT3	585 [266]	MT3-E	695 [316]
350	250	395	315	275	292		800 [363]		1006 [456]		780 [354]		1006 [456]
400	315	470	375	325	349	MT4	825 [374]	MT4-E	1031 [467]	MT4	805 [365]	MT4-E	1031 [467]
500	400	595	475	415	443		915 [415]		1121 [508]		915 [415]		1121 [510]
600	450	670	535	470	499	LT1	1398 [634]	LT1-E	1476 [670]	LT1	1398 [634]	LT1-E	1476 [670]
700	500	780	625	545	579		1700 [771]		1839 [834]		1650 [748]		1740 [789]
800	560	890	715	620	662	LT2	1882 [854]	LT2-E	1954 [886]	LT2	1805 [819]	LT2-E	1852 [842]
900	630	990	795	690	736		1920 [871]		2054 [931]		1882 [854]		2054 [932]
1000	710	1100	880	770	818	LT3	1950 [884]	LT3-E	2084 [945]	LT3	1915 [869]	LT3-E	2064 [936]
1100	800	1210	970	845	900		2465 [1118]		2564 [1163]		2331 [1057]		2515 [1141]
1200	900	1330	1060	925	987		2568 [1167]		2958 [1245]		2465 [1121]		2855 [1298]
1300	970	1430	1145	1000	1064		2718 [1236]		3408 [1549]		2609 [1186]		2999 [1363]
1400	1000	1540	1235	1075	1145	HT2	2858 [1299]	HT2-E	3548 [1613]	HT2	2782 [1265]	HT2-E	3172 [1442]
1500	1120	1650	1325	1155	1228		3598 [1635]		3690 [1677]		3540 [1606]		3620 [1642]
1600	1200	1770	1415	1235	1316		3748 [1703]		3840 [1745]		3702 [1679]		3800 [1724]
1800	1350	1990	1595	1390	1481		3848 [1749]		4376 [1943]		3798 [1723]		3875 [1758]
2000	1450	2200	1765	1535	1636	HT3	3978 [1808]	HT3-E	4506 [2048]	HT3	3945 [1789]	HT3-E	4250 [1928]
2300	1700	2530	2030	1765	1882		4075 [1850]		4600 [2088]		4015 [1821]		4340 [1969]
2500	1850	2755	2205	1920	2045		4650 [2111]		4750 [2157]		4600 [2087]		4750 [2155]
2800	2100	3100	2480	2160	2303		5000 [2270]		5100 [2315]		4945 [2243]		5100 [2313]
3000	2250	3320	2660	2315	2468	HT3	5225 [2372]	HT3-E	5180 [2350]	HT3	5180 [2350]	HT3-E	5100 [2313]
3500	2600	3855	3085	2685	2618		5550 [2520]		5490 [2490]		5490 [2490]		5490 [2490]

1. Approximate Values

Rating Table (continued)

Motor Size		Lineator Rating (3-Phase)					208, 240V (60Hz)				400, 440V (50Hz)			
HP	kW	Input Amps				Output kW	Standard Enclosure		Enhanced Enclosure		Standard Enclosure		Enhanced Enclosure	
		208V 60Hz	220/ 240V 50/60Hz	380/ 400V 50Hz	415/ 440V 50Hz		Case Style	Weight lbs [kg] <sup>[1]</sup>	Case Style	Weight lbs [kg] <sup>[1]</sup>	Case Style	Weight lbs [kg] <sup>[1]</sup>	Case Style	Weight lbs [kg] <sup>[1]</sup>
5	4	14	13	8	7	4.5	SU1	65 [30]	SU1-E	75 [34]	SU1	58 [26]	SU1-E	68 [31]
7.5	5.5	20	18	11	10	6.3		76 [35]		86 [39]		67 [30]		77 [35]
10	7.5	27	24	14	13	8.5	SU2	80 [36]	SU2-E	80 [36]	SU2	78 [35]	SU2-E	88 [40]
15	11	40	36	21	19	13		117 [53]		127 [58]		90 [41]		100 [45]
20	15	53	48	28	25	17	SU3	138 [63]	SU3-E	148 [67]	SU3	118 [54]	SU3-E	128 [58]
25	18.5	66	60	35	32	21		154 [70]		164 [74]		130 [59]		140 [64]
30	22	79	72	42	38	25	SU4	189 [86]	SU4-E	199 [90]	SU4	142 [65]	SU4-E	152 [69]
40	30	105	95	55	51	34		253 [115]		263 [119]		154 [70]		164 [74]
50	37.5	131	119	69	63	42	SU4	275 [125]	MT3-E	333 [151]	SU3	186 [84]	SU3-E	196 [88]
60	45	158	143	83	76	51		315 [143]		337 [153]		218 [99]		228 [103]
75	55	196	178	103	95	63	SU4	325 [148]	MT3-E	399 [181]	SU4	304 [138]	SU4-E	314 [142]
100	75	260	236	137	125	84		442 [201]		516 [235]		323 [147]		414 [188]
125	90	323	294	170	156	104	SU4	468 [213]	MT3-E	542 [246]	SU4	345 [156]	MT3-E	434 [197]
150	110	388	353	204	187	125		553 [251]		627 [285]		365 [166]		469 [213]
200	150			274	250	168				415 [189]	MT3	578 [262]	MT4-E	600 [273]
250	185			340	312	209				585 [266]	MT4	800 [363]	LT1-E	1006 [456]
300	200			410	374	251				825 [374]	LT1	915 [415]	LT2-E	1121 [508]
350	250			475	436	292				1098 [499]	LT2	1700 [771]	HT2-E	1839 [834]
400	315			565	520	349				1882 [854]	LT3	1920 [871]	HT3-E	1954 [886]
500	400			720	660	443				1950 [884]	LT3	2465 [1118]		2054 [931]
600	450			810	740	499				2568 [1167]	HT2-E	2718 [1236]		2084 [945]
700	500			940	865	579				2858 [1299]	HT3-E	2858 [1299]		2564 [1163]
800	560			1075	985	662				3598 [1635]	HT2-E	3748 [1703]		2958 [1245]
900	630			1200	1100	736				3748 [1703]	HT3-E	3848 [1745]		3408 [1549]
1000	710			1335	1220	818				3848 [1749]	HT3-E	3978 [1808]		3548 [1613]
1100	800			1470	1340	900				4075 [1850]	HT3-E	4650 [2111]		3690 [1677]
1200	900			1610	1470	987				5000 [2270]	HT3	5225 [2372]		3840 [1745]
1300	970			1735	1585	1064				5550 [2520]				4376 [1943]
1400	1000			1870	1710	1145								4506 [2048]
1500	1120			2000	1835	1228								4600 [2088]
1600	1200			2145	1965	1316								4750 [2157]
1800	1350			2410	2210	1481								5100 [2315]
2000	1450			2670	2440	1636								
2300	1700			3065	2810	1882								
2500	1850			3335	3050	2045								
2800	2100			3750	3435	2303								
3000	2250			4020	3680	2468								
3500	2600			4265	3905	2618								

1. Approximate Values

7.4 Recommended Circuit Breaker or Fuse Protection Table

Lineator Size		Recommended Circuit Breaker or Fuse Sizes – NEC [IEC]						
HP	kW	460/ 480V 60Hz NEC	575/ 600V 60Hz NEC	660/ 690V 50/60Hz NEC [IEC]	208V 60Hz NEC	220/ 240V 50/60Hz NEC [IEC]	380/ 400V 50Hz IEC	415/ 440V 50Hz IEC
5	4	10	10	10	20	20	10	10
7.5	5.5	15	10	10	25	25	16	16
10	7.5	15	15	10	35	30	20	16
15	11	25	20	15	50	45	32	25
20	15	30	25	20	70	60	35	32
25	18.5	40	30	25	90	80	45	40
30	22	45	35	30	100	90	63	50
40	30	60	45	40	150	125	80	63
50	37.5	80	60	50	175	150	100	80
60	45	90	70	60	200	200	125	100
75	55	125	90	80	250	225	160	125
100	75	150	125	100	350	300	200	160
125	90	175	150	125	400	400	224	200
150	110	225	175	150	500	450	250	250
200	150	300	225	200			350	315
250	185	350	300	250			425	400
300	200	450	350	300			560	500
350	250	500	400	350			630	630
400	315	600	500	400			710	710
500	400	700	600	500			900	800
600	450	800	700	600			1000	1000
700	500	1000	800	700			1250	1000
800	560	1200	900	800			1600	1250
900	630	1200	1000	900			1600	1600
1000	710	1400	1200	1000			2000	1600
1100	800	1600	1200	1200			2000	1600
1200	900	1800	1400	1200			2000	2000
1300	970	1800	1400	1200			2500	2000
1400	1000	2000	1600	1400			2500	2500
1500	1120	2000	1800	1400			2500	2500
1600	1200	2500	1800	1600			3000	2500
1800	1350	2500	2000	1800			3200	3000
2000	1450	3000	2500	2000			3200	3200
2300	1700	4000	2500	2500			4000	4000
2500	1850	4000	3000	2500			4000	4000
2800	2100	4000	3000	3000			5000	5000
3000	2250	5000	4000	3000			5000	5000
3500	2600	5000	4000	4000			6000	5000

1. These are recommended values only and do not supersede the local code requirements. Refer to NEC and/or IEC sizing rules for overcurrent protection device.
2. 100% - rated circuit breakers recommended for continuous load.

7.5 Lineator Type Operational Curve

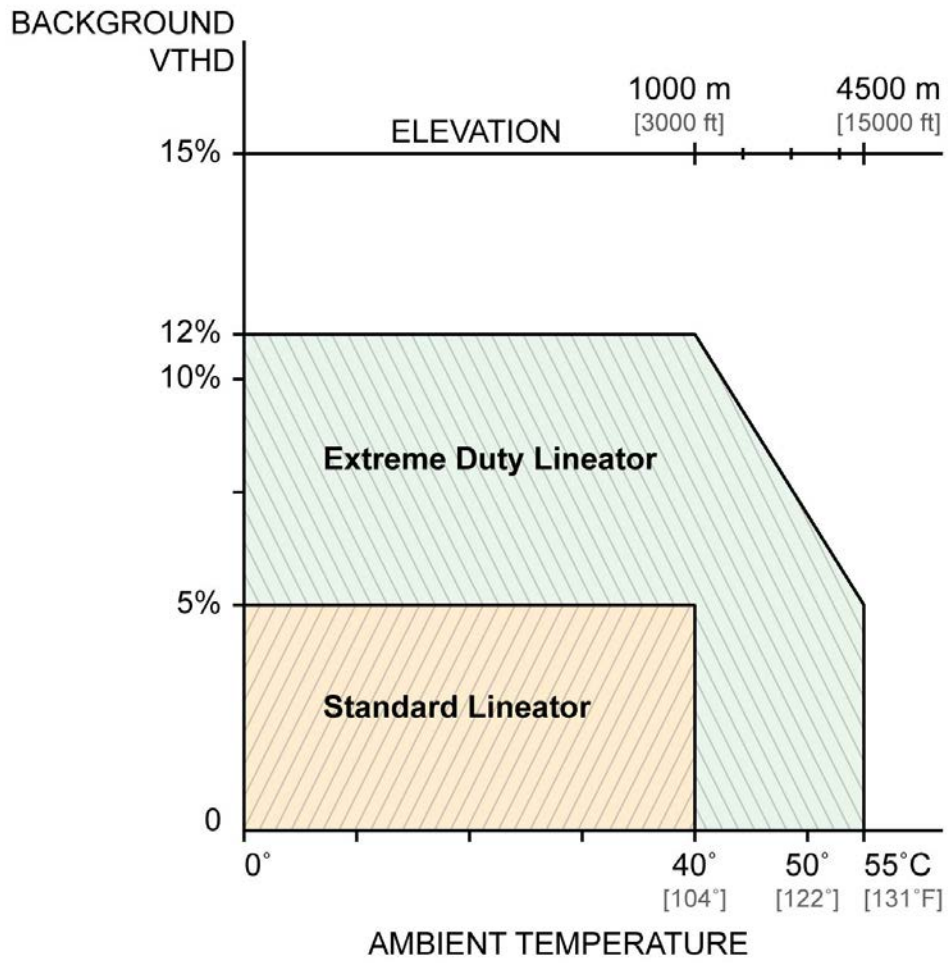

7.6 Enclosure Dimensions

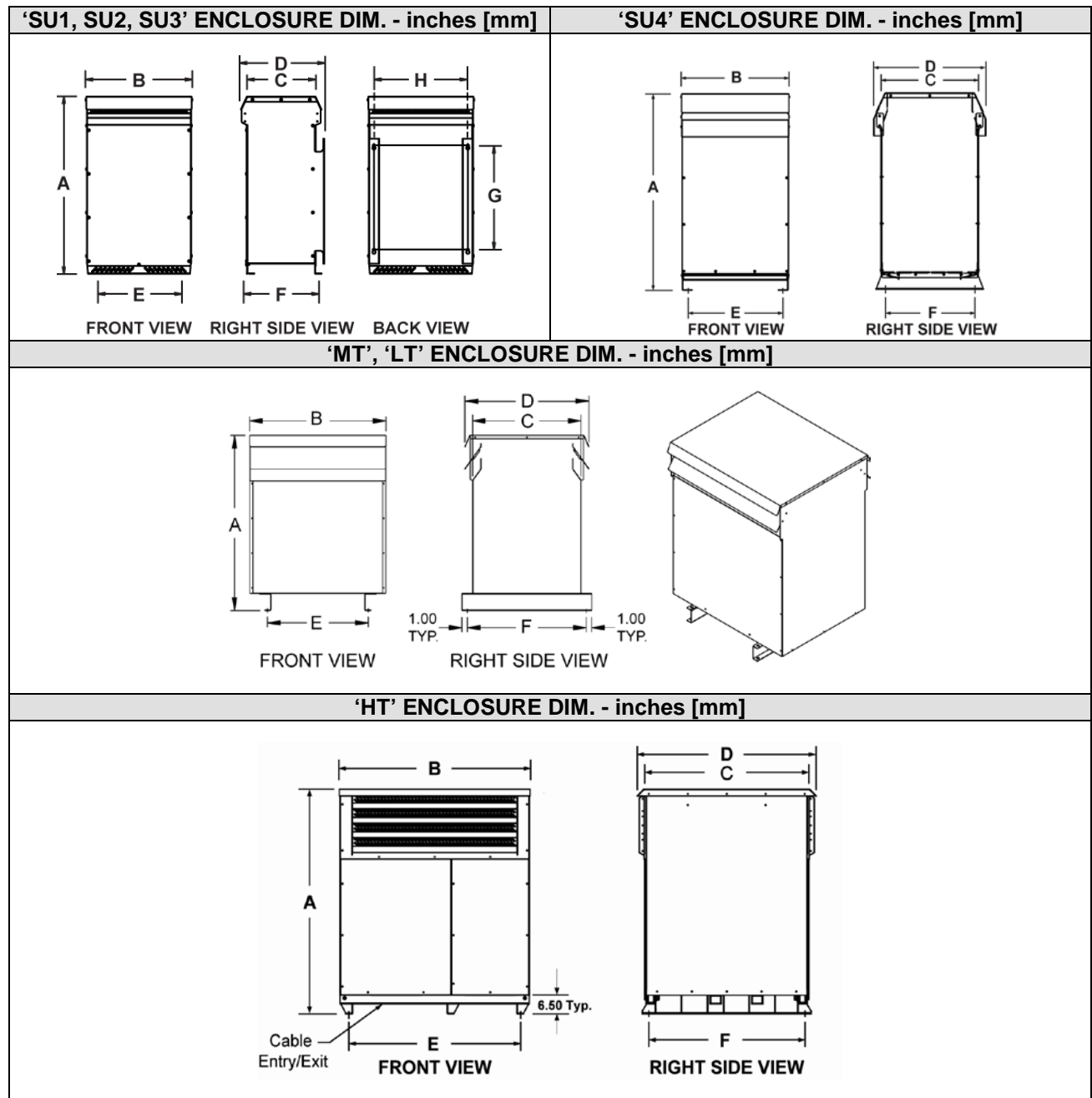

CASE STYLE		ENCLOSURE DIMENSIONS - inches [mm]							
Standard	Enhanced	A	B	C	D	E	F	G	H
SU1	SU1-E	23.50 [597]	11.25 [286]	8.75 [222]	11.25 [286]	9.00 [229]	8.50 [216]	12.00 [305]	9.00 [228]
SU2	SU2-E	29.50 [749]	13.25 [336]	10.25 [260]	12.75 [324]	11.00 [279]	10.00 [254]	16.00 [406]	11.00 [279]
SU3	SU3-E	34.00 [864]	20.25 [514]	13.25 [336]	16.00 [406]	18.00 [457]	13.00 [330]	20.00 [508]	18.00 [457]
SU4	SU4-E	40.00 [1016]	22.00 [559]	18.50 [470]	23.00 [584]	20.00 [508]	20.00 [508]		
MT3	MT3-E	45.00 [1143]	26.00 [661]	21.00 [534]	25.00 [635]	21.50 [546]	19.00 [483]		
MT4	MT4-E	51.50 [1308]	32.00 [813]	25.50 [648]	29.50 [749]	23.50 [597]	23.50 [597]		
LT1	LT1-E	59.00 [1499]	39.50 [1003]	30.00 [762]	34.00 [864]	24.00 [610]	32.00 [813]		
LT2	LT2-E	66.00 [1677]	44.00 [1118]	34.00 [864]	38.00 [965]	26.00 [660]	36.00 [915]		
LT3	LT3-E	75.00 [1905]	48.50 [1232]	39.00 [991]	43.00 [1092]	27.50 [699]	41.00 [1041]		
HT2	HT2-E	78.00 [1981]	58.50 [1486]	51.00 [1295]	56.25 [1428]	52.50 [1333]	50.75 [1289]		
HT3	HT3-E	84.00 [2134]	68.50 [1740]	59.00 [1499]	64.50 [1638]	62.50 [1587]	58.75 [1492]		



## 8.0 Troubleshooting Guide

**Caution:** Before entering or working on the Lineator™, it should be de-energized, properly grounded and isolated. Work that requires that the filter be energized, must only be performed by a qualified technician.

**1. PROBLEM: No power to Lineator™**

- a. Possible cause: Power to the filter is turned off.

Solution: Check that upstream circuit breaker is closed or that fuses are installed in upstream fused disconnect and are not blown.

**2. PROBLEM: Capacitor phase currents are unbalanced by more than 10%**

- a. Possible cause: One or more capacitors have failed.

Solution: Most Lineator™ filters have their capacitors connected in a wye configuration (ie. two jumpers create a common point on each set of three capacitors). Locating a failed capacitor can be simplified by measuring the voltage between the common neutral point of each set to ground while the filter is energized. If the voltage difference is greater than 10V, at least one of the capacitors in that set has failed or has a blown fuse. With power to the Lineator™ turned off and safely isolated, check for evidence of failure in the form of a bulged case. Replace any failed capacitors.

- b. Possible cause: Blown capacitor fuse.

Solution: If equipped with the blown fuse indicator option, check all capacitor fuse blocks for evidence of a blown fuse. If not equipped with blown fuse indicators, measure the voltage across the terminals of each fuseholder with power applied to the filter. If voltage is not near 0, fuse is blown and should be replaced. Make sure that fuse rating used is appropriate for capacitor size. Check with the factory for fuse sizing. To simplify location of a blown capacitor fuse, check the voltage between the common neutral point of each set of three capacitors to ground as per Item 2a above.

**3. PROBLEM: Harmonic mitigation performance does not seem to match performance guarantee**

- a. Possible cause: ITHD measurement is being used instead of ITDD.

Solution: Check loading of VFD and determine ITDD value by multiplying measured ITHD value by percent loading. Check this value against performance guarantee.

- b. Possible cause: One or more capacitors have failed.

Solution: Check for failed capacitor and replace if necessary (see Item 2a).

- c. Possible cause: One or more capacitor fuses have blown.

Solution: Check for blown capacitor fuse and replace if necessary (see Item 2b).

- d. Possible cause: High background voltage distortion.

Solution: Check that background voltage distortion is below 5%. If above 5%, consider harmonic mitigation for other harmonic generating loads.

**4. PROBLEM: Lineator™ output voltage is not within specification**

- a. Possible cause: Filter input voltage is not within specification.

Solution: Check the AC input voltage and verify that it is within specification. Change upstream transformer taps if necessary.

- b. Possible cause: One or more capacitors have failed.

Solution: Check for failed capacitor and replace if necessary (see Item 2a).

- c. Possible cause: One or more capacitor fuses have blown.

Solution: Check for blown capacitor fuse and replace if necessary (see Item 2b).







**MIRUS International Inc.**  
31 Sun Pac Blvd.  
Brampton, Ontario  
Canada L6S 5P6

**1 - 888 - TO - MIRUS (1 - 888 - 866 - 4787)**  
**Tel: (905) 494-1120**  
**Fax: (905) 494-1140**  
E-Mail: [mirus@mirusinternational.com](mailto:mirus@mirusinternational.com)  
Website: [www.mirusinternational.com](http://www.mirusinternational.com)